

User Manual



DG2020A Data Generator With P3410 & P3420 Pods

071-0053-50

Copyright © Tektronix, Inc. All rights reserved.

Tektronix products are covered by U.S. and foreign patents, issued and pending. Information in this publication supercedes that in all previously published material. Specifications and price change privileges reserved.

Tektronix, Inc., P.O. Box 500, Beaverton, OR 97077

TEKTRONIX and TEK are registered trademarks of Tektronix, Inc.

WARRANTY

Tektronix warrants that the products that it manufactures and sells will be free from defects in materials and workmanship for a period of one (1) year from the date of shipment. If a product proves defective during this warranty period, Tektronix, at its option, either will repair the defective product without charge for parts and labor, or will provide a replacement in exchange for the defective product.

In order to obtain service under this warranty, Customer must notify Tektronix of the defect before the expiration of the warranty period and make suitable arrangements for the performance of service. Customer shall be responsible for packaging and shipping the defective product to the service center designated by Tektronix, with shipping charges prepaid. Tektronix shall pay for the return of the product to Customer if the shipment is to a location within the country in which the Tektronix service center is located. Customer shall be responsible for paying all shipping charges, duties, taxes, and any other charges for products returned to any other locations.

This warranty shall not apply to any defect, failure or damage caused by improper use or improper or inadequate maintenance and care. Tektronix shall not be obligated to furnish service under this warranty a) to repair damage resulting from attempts by personnel other than Tektronix representatives to install, repair or service the product; b) to repair damage resulting from improper use or connection to incompatible equipment; c) to repair any damage or malfunction caused by the use of non-Tektronix supplies; or d) to service a product that has been modified or integrated with other products when the effect of such modification or integration increases the time or difficulty of servicing the product.

THIS WARRANTY IS GIVEN BY TEKTRONIX IN LIEU OF ANY OTHER WARRANTIES, EXPRESS OR IMPLIED. TEKTRONIX AND ITS VENDORS DISCLAIM ANY IMPLIED WARRANTIES OF MERCHANTABILITY OR FITNESS FOR A PARTICULAR PURPOSE. TEKTRONIX' RESPONSIBILITY TO REPAIR OR REPLACE DEFECTIVE PRODUCTS IS THE SOLE AND EXCLUSIVE REMEDY PROVIDED TO THE CUSTOMER FOR BREACH OF THIS WARRANTY. TEKTRONIX AND ITS VENDORS WILL NOT BE LIABLE FOR ANY INDIRECT, SPECIAL, INCIDENTAL, OR CONSEQUENTIAL DAMAGES IRRESPECTIVE OF WHETHER TEKTRONIX OR THE VENDOR HAS ADVANCE NOTICE OF THE POSSIBILITY OF SUCH DAMAGES.

Table of Contents

General Safety Summary	xi
Service Safety Summary	xiii
Preface	xv

Getting Started

Getting Started	1-1
Product Description	1-1
Initial Inspection	1-2
Options	1-3
Power Cord Options	1-3
Accessories	1-4
Installation	1-7
Power On	1-12
Start-up Diagnostics	1-14
Power Off	1-14

Operating Basics

Operating Basics	2-1
Functional Overview	2-1
Internal Structure and Operating Principles	2-10
Data Structure Basics	2-13
Operating Modes Overview	2-16
Basic Menu Operation	2-17
Menu Operations	2-17
Menu Notation	2-18
Menu Item Display	2-19
Numeric Input	2-20
Pattern Data Display Format	2-23
Edit Operations	2-25
Area and Point Cursors	2-26
Text Input	2-28
Pop up Confirmation Windows	2-28
Menu Trees	2-30
Basic Operation Examples	2-35
Required Equipment	2-35
Before Starting Examples	2-36
Operating Procedure Sequences	2-36
Equipment Connections	2-37
Example 1: Creating a Pattern and Storing it in a File	2-39
Example 2: Loading and Editing a Pattern Stored in a File	2-42
Example 3: Signal Output	2-46
Example 4: Creating a Sequence	2-54

Reference

Reference	3-1
Operation Outlines	3-2
Outlines for Pattern Data and Sequence Creations	3-3
Advanced Control for Sequence	3-4
Edit Menu	3-5
CRT Display	3-7
File Menu	3-9
Settings Menu	3-17
Block Menu	3-24
Execute Action Menu	3-28
Enhanced Action Menu	3-42
Make Sequence Menu	3-54
Undo	3-60
SETUP Menu	3-61
CRT Display	3-63
Group Assign Menu	3-65
Pod Assign Menu	3-68
Level/Delay Menu	3-70
Pod Control Menu	3-71
Run Mode Menu	3-73
Trigger Menu	3-76
Oscillator Menu	3-77
APPLICATION Menu	3-79
APPLICATION Menu	3-79
UTILITY Menu	3-81
Mass Memory Menu	3-83
Display/Hardcopy Menu	3-86
System Menu	3-89
Status Menu	3-93
Diag Menu	3-93

Appendices

Appendix A: Performance Characteristics	A-1
Warranted Characteristics	A-2
Typical Characteristics	A-7
Nominal Traits	A-9
Certification and Compliances	A-14
Appendix B: Performance Verification	B-1
Before Running the Operation Tests	B-2
Test Procedure Notes	B-4
Self Tests	B-5
Performance Tests for the DG2020A/Pod Combination	B-6
P3410 Pod Performance Test	B-17
P3420 Pod Performance Test	B-24

Appendix C: Miscellaneous	C-1
Repackaging for Shipment	C-1
Inspection and Cleaning Procedures	C-2
Factory Settings	C-4
Conversion Table Examples	C-6

Index

List of Figures

Figure 1-1: Pod connection	1-9
Figure 1-2: Yellow index mark and yellow line for cable connection .	1-10
Figure 1-3: Rear panel controls used in start up	1-12
Figure 1-4: ON/STBY switch	1-13
Figure 2-1: Front panel overall view	2-2
Figure 2-2: Front panel button detail	2-3
Figure 2-3: Rear panel	2-4
Figure 2-4: Floppy disk drive	2-5
Figure 2-5: Display elements	2-6
Figure 2-6: P3410 front panel and rear panel	2-8
Figure 2-7: P3420 front panel and rear panel	2-9
Figure 2-8: Hardware block diagram	2-10
Figure 2-9: Inhibit operation timing	2-12
Figure 2-10: Data structure image	2-15
Figure 2-11: Menu buttons and bezel buttons	2-17
Figure 2-12: Numeric keys, units button, delete key, and enter key ..	2-20
Figure 2-13: Numeric input using the numeric keys	2-21
Figure 2-14: General purpose knob and arrow buttons	2-22
Figure 2-15: Knob icon and underscore	2-22
Figure 2-16: Timing display format	2-23
Figure 2-17: Table display format	2-24
Figure 2-18: Binary display format	2-24
Figure 2-19: Pattern data editing procedure	2-26
Figure 2-20: Cursor display in editing operations	2-27
Figure 2-21: Character input menu	2-28
Figure 2-22: Popup confirmation window	2-29
Figure 2-23: Operating buttons and menu layout	2-36
Figure 2-24: Pod connection	2-37
Figure 2-25: Yellow index mark and yellow line for cable connection	2-38
Figure 2-26: Binary pattern creation	2-41
Figure 2-27: Pattern edited in example 2	2-45
Figure 2-28: Pod channel data bit allocation	2-49
Figure 2-29: Output voltage level and delay time display for the P3420 pod	2-51

Figure 2-30: P3410 pod/oscilloscope connection	2-52
Figure 2-31: P3420 pod/oscilloscope connection	2-52
Figure 2-32: Block separation	2-56
Figure 2-33: Sample subsequence	2-59
Figure 2-34: Sample sequence	2-60
Figure 2-35: Line pointer	2-61
Figure 2-36: Sample sequence	2-63
Figure 2-37: Pod assignment	2-64
Figure 3-1: Operation flow for pattern data output #1	3-2
Figure 3-2: Operation flow for pattern data output #2	3-2
Figure 3-3: EDIT menu (timing display)	3-7
Figure 3-4: Import configuration menu (file format: AWG2000 series waveform file)	3-11
Figure 3-5: Data write in terms of point positions	3-12
Figure 3-6: Data write in terms of data bit positions	3-12
Figure 3-7: Export config menu	3-15
Figure 3-8: Settings popup menu	3-17
Figure 3-9: Reference mark "M" display	3-18
Figure 3-10: Reference group setting (timing display)	3-19
Figure 3-11: Arrow button action display (timing display)	3-20
Figure 3-12: Arrow button operation menu	3-21
Figure 3-13: Block popup menu	3-24
Figure 3-14: Block relative cursor movement	3-25
Figure 3-15: Divide a block	3-25
Figure 3-16: Combine blocks	3-26
Figure 3-17: Change a block size	3-27
Figure 3-18: Action popup menu	3-28
Figure 3-19: Editing area range	3-29
Figure 3-20: Cut	3-31
Figure 3-21: Paste – insert	3-31
Figure 3-22: Paste – replace	3-32
Figure 3-23: Set data to high	3-32
Figure 3-24: Set data to low	3-32
Figure 3-25: Insert high data	3-33
Figure 3-26: Insert low data	3-33
Figure 3-27: Invert data	3-33
Figure 3-28: Mirror vertical	3-34
Figure 3-29: Mirror horizontal	3-35

Figure 3-30: Magnify	3-35
Figure 3-31: Shift left (add zero)	3-37
Figure 3-32: Shift right (add zero)	3-37
Figure 3-33: Shift left	3-38
Figure 3-34: Shift right	3-38
Figure 3-35: Rotate left	3-39
Figure 3-36: Rotate right	3-39
Figure 3-37: Standard pattern data	3-41
Figure 3-38: Creating the clock pattern	3-42
Figure 3-39: Clock pattern popup menu	3-43
Figure 3-40: Register value and tap setting example	3-44
Figure 3-41: Shift register generator popup menu	3-45
Figure 3-42: Logical operation example (AND)	3-47
Figure 3-43: Logical operation popup menu	3-47
Figure 3-44: Bit operation popup menu	3-49
Figure 3-45: Serial code converter menu	3-50
Figure 3-46: Edit code table menu	3-52
Figure 3-47: Make sequence menu and a sequence example	3-54
Figure 3-48: Make sub-sequence menu and a subsequence example ..	3-55
Figure 3-49: Event jump operation timing	3-60
Figure 3-50: SETUP menu	3-63
Figure 3-51: Group assign popup menu	3-65
Figure 3-52: Bit structure assignment	3-66
Figure 3-53: Pod assign popup menu	3-68
Figure 3-54: High-impedance control circuit	3-69
Figure 3-55: Repeat mode pattern data output (when no sequence is defined)	3-73
Figure 3-56: Repeat mode pattern data output (when a sequence is defined)	3-73
Figure 3-57: Single mode pattern data output (when no sequence is defined)	3-74
Figure 3-58: Single mode pattern data output (when a sequence is defined)	3-74
Figure 3-59: Enhanced mode sequence output	3-75
Figure 3-60: Trigger slope and level control	3-76
Figure 3-61: Display/hardcopy menu	3-86
Figure 3-62: System menu	3-89
Figure 3-63: Status menu	3-93
Figure 3-64: Diag menu	3-93

Figure A-1: Trigger delay	A-5
Figure B-1: Operating buttons and menu layout	B-4
Figure B-2: Diagnostics menu	B-5
Figure B-3: Frequency measurement connections	B-6
Figure B-4: External clock input connection	B-8
Figure B-5: Pod connection	B-10
Figure B-6: P3410 data output connectors	B-11
Figure B-7: P3420 data output connectors	B-11
Figure B-8: External trigger operation connections	B-13
Figure B-9: P3410 event input connections	B-15
Figure B-10: P3420 event input connections	B-15
Figure B-11: DG2020A event output connections	B-16
Figure B-12: Pod connection	B-17
Figure B-13: P3410 voltage level display	B-18
Figure B-14: P3410 output pins	B-18
Figure B-15: Pin header cable types	B-18
Figure B-16: Output voltage test connections	B-19
Figure B-17: Variable delay test connections	B-20
Figure B-18: Event input operation confirmation connections	B-22
Figure B-19: Inhibit operation confirmation connections	B-23
Figure B-20: Pod connection	B-24
Figure B-21: P3420 voltage level display	B-25
Figure B-22: P3420 output connectors	B-25
Figure B-23: Output voltage level measurement connections	B-26
Figure B-24: Variable delay precision check	B-29
Figure B-25: Event input operation confirmation connections	B-31
Figure B-26: Inhibit input operation confirmation connections	B-32
Figure C-1: Conversion image example	C-6

List of Tables

Table 1-1: Power cord options	1-4
Table 1-2: Standard accessories	1-4
Table 1-3: Standard accessories for pods	1-4
Table 1-4: Optional accessories	1-5
Table 1-5: Maintenance kit contents	1-6
Table 1-6: Power cord identification	1-11
Table 2-1: DG2030 display elements	2-7
Table 2-2: Data structure terms	2-14
Table 2-3: Run modes	2-16
Table 2-4: Update modes	2-16
Table 2-5: Bottom menu item display	2-19
Table 2-6: Side and sub menu item display	2-19
Table 2-7: Numeric input example	2-21
Table 3-1: Menu functions	3-5
Table 3-2: Edit menu crt display	3-8
Table 3-3: Import parameters	3-11
Table 3-4: Export parameters	3-16
Table 3-5: Arrow button functions	3-21
Table 3-6: Pattern data display format	3-23
Table 3-7: Block relative cursor movement	3-24
Table 3-8: Numeric input differences	3-36
Table 3-9: Standard pattern data descriptions	3-40
Table 3-10: Parameter items	3-43
Table 3-11: Shift register generator parameters	3-45
Table 3-12: Logical operation parameters	3-48
Table 3-13: Bit operation parameters	3-49
Table 3-14: Serial code converter parameters	3-51
Table 3-15: Edit code table parameters	3-52
Table 3-16: Numeric key description	3-53
Table 3-17: Setup menu functions	3-61
Table 3-18: Setup menu CRT display	3-64
Table 3-19: Impedance state control methods	3-69
Table 3-20: Menu functions	3-81
Table 3-21: Error code	3-94

Table A-1: Warranted electrical characteristics	A-2
Table A-2: Warranted environmental characteristics	A-6
Table A-3: Electrical characteristics (typical)	A-7
Table A-4: Period Jitter accuracy	A-8
Table A-5: Cycle to Cycle Jitter accuracy	A-8
Table A-6: Nominal traits – electrical characteristics	A-9
Table A-7: Nominal traits – mechanical characteristics	A-13
Table A-8: Certifications and compliances	A-14
Table B-1: Performance check disk's file list	B-2
Table B-2: Required equipment	B-3
Table B-3: Error Codes	B-5
Table B-4: Internal clock frequency precision (PLL off)	B-8
Table B-5: Delay precision	B-21
Table B-6: High level output voltage ranges for a 1 MW load	B-27
Table B-7: Low level output voltage ranges for a 1 MW load	B-28
Table B-8: Delay precision	B-30
Table C-1: External inspection check list	C-2
Table C-2: Factory settings	C-4

General Safety Summary

Review the following safety precautions to avoid injury and prevent damage to this product or any products connected to it. To avoid potential hazards, use this product only as specified.

Only qualified personnel should perform service procedures.

To Avoid Fire or Personal Injury

Use Proper Power Cord. Use only the power cord specified for this product and certified for the country of use.

Connect and Disconnect Properly. Do not connect or disconnect probes or test leads while they are connected to a voltage source.

Ground the Product. This product is grounded through the grounding conductor of the power cord. To avoid electric shock, the grounding conductor must be connected to earth ground. Before making connections to the input or output terminals of the product, ensure that the product is properly grounded.

Observe All Terminal Ratings. To avoid fire or shock hazard, observe all ratings and markings on the product. Consult the product manual for further ratings information before making connections to the product.

Do Not Operate Without Covers. Do not operate this product with covers or panels removed.

Use Proper Fuse. Use only the fuse type and rating specified for this product.

Avoid Exposed Circuitry. Do not touch exposed connections and components when power is present.

Do Not Operate With Suspected Failures. If you suspect there is damage to this product, have it inspected by qualified service personnel.

Do Not Operate in Wet/Damp Conditions.

Do Not Operate in an Explosive Atmosphere.

Keep Product Surfaces Clean and Dry.

Provide Proper Ventilation. Refer to the manual's installation instructions for details on installing the product so it has proper ventilation.

Symbols and Terms

Terms in this Manual. These terms may appear in this manual:



WARNING. *Warning statements identify conditions or practices that could result in injury or loss of life.*



CAUTION. *Caution statements identify conditions or practices that could result in damage to this product or other property.*

Terms on the Product. These terms may appear on the product:

DANGER indicates an injury hazard immediately accessible as you read the marking.

WARNING indicates an injury hazard not immediately accessible as you read the marking.

CAUTION indicates a hazard to property including the product.

Symbols on the Product. The following symbols may appear on the product:



WARNING
High Voltage



Protective Ground
(Earth) Terminal



CAUTION
Refer to Manual



Double
Insulated

Service Safety Summary

Only qualified personnel should perform service procedures. Read this *Service Safety Summary* and the *General Safety Summary* before performing any service procedures.

Do Not Service Alone. Do not perform internal service or adjustments of this product unless another person capable of rendering first aid and resuscitation is present.

Disconnect Power. To avoid electric shock, disconnect the mains power by means of the power cord or, if provided, the power switch.

Use Caution When Servicing the CRT. To avoid electric shock or injury, use extreme caution when handling the CRT. Only qualified personnel familiar with CRT servicing procedures and precautions should remove or install the CRT.

CRTs retain hazardous voltages for long periods of time after power is turned off. Before attempting any servicing, discharge the CRT by shorting the anode to chassis ground. When discharging the CRT, connect the discharge path to ground and then the anode. Rough handling may cause the CRT to implode. Do not nick or scratch the glass or subject it to undue pressure when removing or installing it. When handling the CRT, wear safety goggles and heavy gloves for protection.

Use Care When Servicing With Power On. Dangerous voltages or currents may exist in this product. Disconnect power, remove battery (if applicable), and disconnect test leads before removing protective panels, soldering, or replacing components.

To avoid electric shock, do not touch exposed connections.

X-Radiation. To avoid x-radiation exposure, do not modify or otherwise alter the high-voltage circuitry or the CRT enclosure. X-ray emissions generated within this product have been sufficiently shielded.

Preface

This is the User Manual for the DG2020A Data Generator, P3410 TTL Pod, and the P3420 Variable Pod.

Getting Started covers the features of the DG2020A, initial inspection, options and accessories, installation procedures, and power on and off procedures. In particular, the installation section covers the procedures required prior to turning on the unit and points that require special care or caution.

Operating Basics starts out by introducing the terminology used with the DG2020A. Next it presents the internal structure, operating principles, basic operating procedures, and numeric input methods. Finally, this section describes the operating procedures for outputting waveforms using this instrument by presenting simple examples.

Reference describes the functions and use of this instrument's main menus in detail.

Appendices describe product specifications, performance verification instructions, and other information.

Related Manuals

Other documentation for the instrument includes:

- The DG2020A Programmer Manual (Tektronix part number 071-0054-XX) explains how to control the DG2020A with a computer through the GPIB or RS-232-C interface. This manual is a standard accessory.
- The DG2020A Service Manual (Tektronix part number 071-0055-XX) provides information to maintain and service DG2020A, and provides a complete board-level description of the instrument's operation. This manual is an optional accessory.

Conventions

The following typographical conventions are used in this manual.

- Names of front panel controls and menu item names are printed in the manual in bold with the same case (e.g., initial capitals, all upper case) as they appear on the unit itself.

- Sections 2, 3, and Appendix B describe instrument functions by presenting operating procedures. Each operating procedure is presented in order starting with step 1, and progresses until the end of the procedure. Tables such as the one below show in these steps. Execute the action in left end of the top row first. Then execute actions from left to right along the row. When one row has been completed, move to the left end of the next row down, and repeat. For pop-up menus, use the general-purpose knob to select items from the menu list. Operations such as operation 6 (below) do not involve pressing the buttons shown in the row above, but rather are descriptions of operations to be performed.

Menu button	Bottom button	Popup menu	Side button	Front panel button
Operation 1	Operation 2	Operation 3	Operation 4	Operation 5
Operation 6 (For example, set to xx with general-purpose knob.)				
			Operation 7	

Getting Started

This section provides the following:

- Description and features of the DG2020A
- Initial inspection
- Standard and optional accessories
- Installation procedures
- Power on and off procedures

Product Description

The DG2020A is a portable digital data generator designed for high performance and ease of use. The DG2020A is easy to use for testing and evaluating semiconductors and logic circuits, which are continually becoming faster and more complex.

The DG2020A provides high performance and a wide range of functions in a compact package. Features include the following:

- Maximum data rate of 200 MHz
- 64 K word pattern memory
- Flexible sequence looping (which does the equivalent of over a billion word patterns)
- 12 channels (with support for up to 36 channels by adding optional modules in 12 channel increments)
- 100 ps timing skew adjustment function
- Variable output levels (from -3 to $+7$ V)

Any memory size from 64 words to 64 K words can be used easily, with no restrictions within that range. TTL output level and variable output level pods can be selected as the data output pods. Both pod types support setting of their output stages to a high-impedance state. Each module supports delays in 4 of its 12 channels with a 100 ps resolution variable delay time.

The DG2020A provides flexible data editing functions, including word and line unit input and extended data creation functions. Also, the DG2020A provides a rich set of functions required for system construction, such as a sequencing function, a jump function using external input, and an inhibit function.

Features

The following, list just a few of the many features of the DG2020A:

- The DG2020A supports subassembly and system testing by simulating the digital signals from incomplete sections of a product.
- Logic function test systems can be constructed by combining this instrument with a logic analyzer.
- Margin tests can be performed by using the DG2020A to generate patterns that have a low probability of occurrence or are difficult to generate.
- Interactive digital simulation systems can be constructed using the sequence output, external jump, and tri-state control functions.
- Flexible data output functions make the DG2020A an ideal data generator for simulation of LCD display units, CCD line and area sensors, and all types of digital circuits.

Initial Inspection

Before unpacking the DG2020A from its shipping carton, inspect the package for signs of external damage. If the carton is damaged, notify the carrier. The carton contains the basic instrument and its standard accessories. Refer to the Standard Accessories list in Section 1.

This instrument was thoroughly inspected for mechanical and electrical defects before shipment. It should be free of marks or scratches. To confirm this, inspect the instrument for physical damage that incurred in transit, and test instrument functionality, by following the Operating Examples in this manual. You can also perform a full Performance Verification as listed in the Appendix B. If a discrepancy is found, contact your local Tektronix Field Office or representative.

NOTE. *At installation time, save the shipping carton and packaging materials for repackaging in case shipment becomes necessary.*

Options

This section describes the options, and standard and optional accessories available for the DG2020A.

The following options are available.

- Option 01 (24-channel output)
- Option 02 (36-channel output)
- Option 1R (rack mounting)

Each of these options will be discussed in detail in the following paragraphs.

Option 01 (24-Channel Output)

This option adds a 12 bit digital port for a total of 24 channels. This option allows 2 individual pods to be used at the same time. Pod cable connections are located on the rear panel. Although pod cables are included with this option, the additional pod is not included. The P3410 or P3420 pod must be ordered separately. Contact your Tektronix sales representative if you intend to add this option to a DG2020A that you are already using.

Option 02 (36-Channel Output)

This option adds two 12 bit digital ports for a total of 36 channels. This option allows 3 individual pods to be used at the same time. Pod cable connections are located on the rear panel. Although pod cables are included with this option, the additional pods are not included. Thus P3410 and/or P3420 pods must be ordered separately. Contact your Tektronix sales representative if you intend to add this option to a DG2020A that you are already using.

Option 1R (Rack Mount)

When option 1R is specified, the DG2020A is shipped configured for mounting in a 19 inch rack. The floppy disk drive is moved so that it can be accessed from the front panel in this instrument. Refer to Table 1-4 for the rack mount part number. Contact your Tektronix sales representative for details on converting a non-rack mounting DG2020A to rack mounting.

See the Instruction Sheet provided with the rack mounting kit for details on the rack mounting adapter.

Power Cord Options

Table 1-1 lists the power cords available with the DG2020A.

Table 1-1: Power cord options

Option	Description	Part number
A1	Europe, 220V/6A	161-0104-06
A2	United Kingdom, 240V/6A	161-0104-07
A3	Australia, 240V/6A	161-0104-05
A4	North America, 240V/6A	161-0104-08
A5	Switzerland, 220V/6A	161-0167-00

Accessories

Standard Accessories

Table 1-2 lists the standard accessories provided with the DG2020A.

Table 1-2: Standard accessories

Standard accessory	Part number
User Manual (this manual)	071-0053-XX
Programmer Manual	071-0054-XX
Performance Check Disk, 3.5-inch	063-2918-XX
GPIB Sample Program Disk, 3.5-inch	063-2919-XX
DG-LINK Application Program Disk, 3.5-inch	063-2920-XX
Pod Connection Cable	174-3548-XX
Power cord 125V/6A	161-0230-01
Certificate of Calibration	

Table 1-3 list the standard accessories for the P3410 and P3420 pods

Table 1-3: Standard accessories for pods

Pod	Standard accessories	Part number
P3410	Set of 12 cables	012-1502-XX
P3420	Set of 12 cables	012-1504-XX
P3410 / P3420	Certificate of Calibration	
P3410 / P3420	Instructions Sheet	

Optional Accessories Table 1-4 lists the optional accessories that are recommended for use with the DG2020A, P3410, and P3420.

Table 1-4: Optional accessories

Optional accessory	DG2020A	P3410	P3420	Part number
Service Manual	X			071-0055-XX
Front Cover	X			200-3232-XX
Oscilloscope Camera Adapter	X			016-1154-XX
Accessory Pouch	X			016-1159-XX
Rackmount kit	X			040-1444-XX
Upgrade kit (add 12/24 output channels)	X			040-1556-XX
Fuse 6A Fast (UL198G/3AG)	X			159-0239-XX
Fuse cap	X			200-2264-XX
Fuse 5A (T) (IEC127)	X			159-0210-XX
Fuse cap	X			200-2265-XX
50 Ω termination	X			011-0049-XX
GPIB Cable	X			012-0991-XX
50 Ω BNC Cable (double shield)	X			012-1256-XX
50 Ω BNC Cable	X			012-1342-XX
50 Ω pin header to pin header cable 20 inch (50.8 cm)	X	X		012-1505-XX
50 Ω SMB to SMB cable 40 inch (101.6 cm)		X	X	012-1458-XX
50 Ω SMB to BNC cable 40 inch (101.6 cm)		X	X	012-1459-XX
50 Ω SMB to pin header cable 20 inch (50.8 cm)		X	X	012-1503-XX
50 Ω SMB to pin header cable 50 inch (127 cm)		X	X	012-1506-XX
Set of 12 SMB-to-pin-header cables with connector 50 inch (127 cm)		X	X	012-1507-XX
1 CH lead set (set of 5) ¹		X	X	012-1508-XX
4 CH lead set (set of 3) ¹		X	X	012-1509-XX
50 Ω SMB to BNC adapter		X	X	015-0671-XX
Connector with 12 pin header sockets ²		X	X	131-5919-XX
Maintenance Kit (See Table 1-5)	X			067-0282-XX
P3410 Exchange Kit		X		650-3420-XX
P3420 Exchange Kit			X	650-3421-XX

1 Used to provide the flexible connection of output signal and ground by attaching to the pin-header side of the 50 Ω cable (SMB to pin header or pin header to pin header).

2 Used for housing of the pin header.

Table 1-5: Maintenance kit contents

Description	Quantity	Part number
Extender-A board (for slot 1, 2, 3, 4)	1	671-2331-XX
Extender-B board (for slot 5)	1	671-2487-XX
Cable kit	1	198-5855-XX
Ejector	2	003-1315-XX
Header	1	131-5537-XX
50 Ω SMB to BNC adapter	2	015-0671-XX
50 Ω SMB to pin header cable 20 inch (50.8 cm)	2	012-1503-XX
50 Ω SMB to SMB cable 40 inch (101.6 cm)	2	012-1458-XX

Installation

Before you begin, refer to the Safety Summary at the front of this manual for power source, grounding, and other safety information.

Before you use the instrument, ensure that it is properly installed and powered on. To properly install and power on the instrument, perform the following steps:

1. Check that the operating environment is correct.

The DG2020A operates correctly in ambient temperatures from +10° C to +40° C and relative humidity from 20% to 80%. If this instrument is stored at temperatures outside this usage temperature range, do not switch on the power until the chassis has come within the operating temperature range. For other information on the other operating environment, see Appendix A: Performance Characteristics.

NOTE. *If you are installing this instrument in the dedicated rack, refer to the instruction sheet that comes with the rack mounting kit.*

2. Before switching on the power, double check that there is nothing blocking the flow of air at the fan and air intake holes.

This instrument takes in outside air and cools itself by forcibly exhausting air with the fan on its left side. Leave space at the sides of this instrument so that the heat generated within the instrument does not build up and harm the operation. There are holes for air intake on the sides and bottom of the cabinet. After switching on the power, double check that the fan is turning. Here are the minimums for the space at the sides of this instrument.

Top : 1 inches

Left and right : 6 inches

Rear : 3 inches



WARNING. *Always unplug the power cord from the socket before checking the line fuse to avoid electrical shock.*

3. Remove the fuse from the fuse holder on the rear panel and check the fuse.

To remove the fuse, turn it counter-clock-wise with a screwdriver while pushing it in. There are two types of fuses provided. Here is the fuse type and rating.

Fuse	Fuse part number	Fuse cap part number
0.25 inch × 1.25 inch (UL 198G,3AG) : 6A FAST, 250 V	159-0239-XX	200-2264-XX
5 mm × 20 mm (IEC 127) : 5A (T), 250 V	159-0210-XX	200-2265-XX

NOTE. *The second fuse listed in the table above is approved under the IEC standards. This fuse is used in equipment sold in the European market.*

4. Check that you have the proper electrical connections.

The DG2020A operates at the following power supply voltage.

Line voltage range	90 V – 250 V
Line frequency	48 Hz – 440 Hz (90 V – 127 V) 48 Hz – 63 Hz (127 V – 250 V)
Maximum power	300 W



CAUTION. *Instruments are shipped with a power cord appropriate for use with normal 115 V power systems. If the DG2020A is to be used with 230 V power, the power cord must be replaced with one appropriate for the power source used. See Table 1-6, Power Cord Identification, for the available power cord types.*

5. Connect the DG2020A (POD A) connector to the pod using a pod connection cable as shown in Figure 1-1.

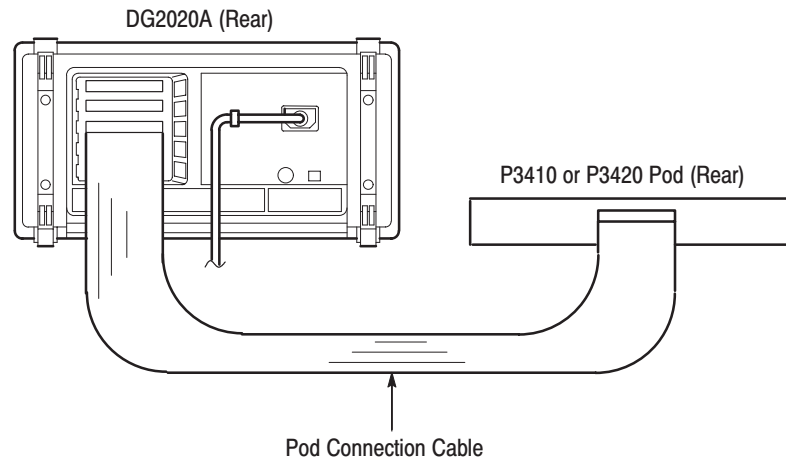

Figure 1-1: Pod connection

Note that the connectors on the DG2020A rear panel are installed with the tab slot down, and the connector on the pod rear panel is installed with the tab slot up (see Figure 1-2).

To connect a cable between the DG2020A and a pod, align the yellow wire end of the cable connector with the triangular yellow index mark on the DG2020A or pod connector. Doing this also correctly aligns the connector alignment tab. See Figure 1-2. Then carefully but firmly insert the cable connector into the DG2020A or pod connector.

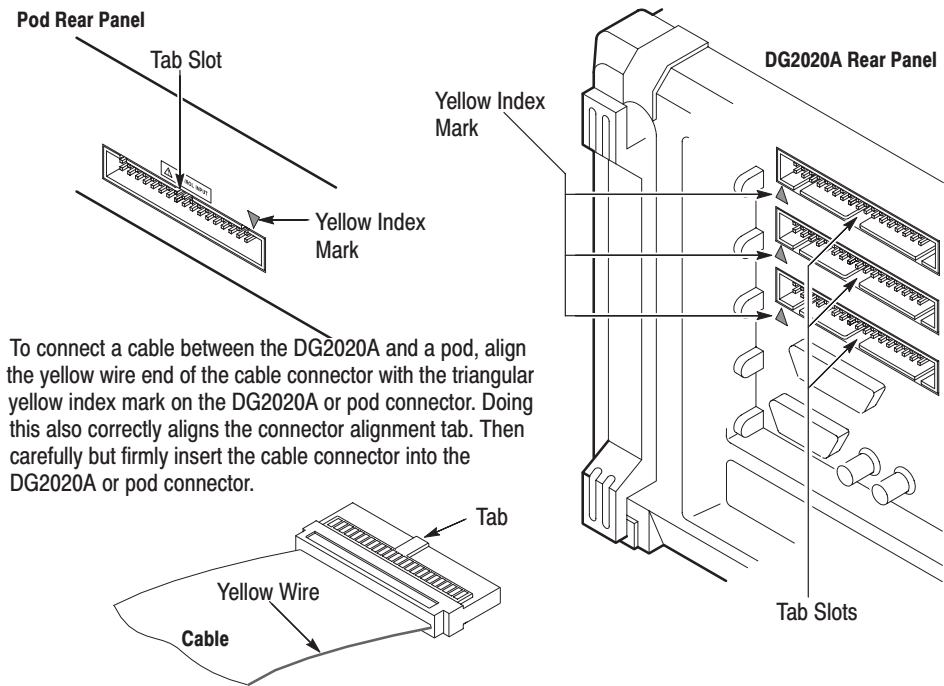

Figure 1-2: Yellow index mark and yellow line for cable connection



CAUTION. Turn off the instrument before connecting it to the pod. Connecting the instrument to the pod with the power on could damage the instrument itself and the pod. When attaching the pod cable, ensure that the plug and socket are aligned correctly.

Make sure that you have correctly inserted the cable plug in the DG2020A and the pod before turning on power. The yellow wire end of the connector must be aligned with the triangular yellow index mark on the DG2020A or pod. Incorrectly connected cables will damage the DG2020A and the pod.

The cable and the pod are coupled very tightly. Hold the connector housing to avoid stress applied to the cable when attaching or removing the cable.

Electrostatic discharge can permanently damage the delicate ICs used in the pod. Do not touch connector pins with bare hands, and do not bring conductive materials, other than the DG2020A connection cable, close to the pod.

6. Connect the proper power cord from the rear panel power connector to the power system.

Table 1-6: Power cord identification

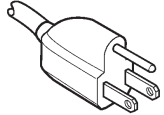
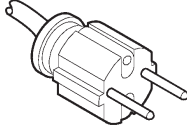
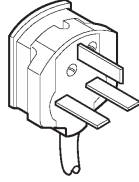
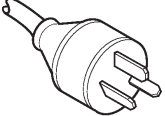
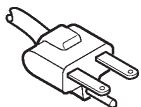
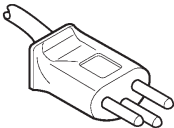
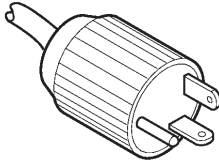
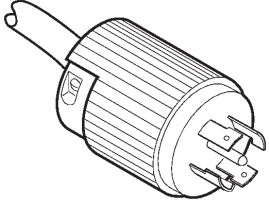
Plug configuration	Normal usage	Option number
	North America 125 V	Standard
	Europe 230 V	A1
	United Kingdom 230 V	A2
	Australia 230 V	A3
	North America 230 V	A4
	Switzerland 230 V	A5
	North American 115V/15A Plug NEMA 5-20P	1A
	North American 120/208V 3-Phase Plug NEMA L21-30P	1B

Power On

7. Push the **PRINCIPAL POWER SWITCH** (shown in Figure 1-3) on the rear panel of this instrument. Power is now applied to the standby circuit of this instrument.

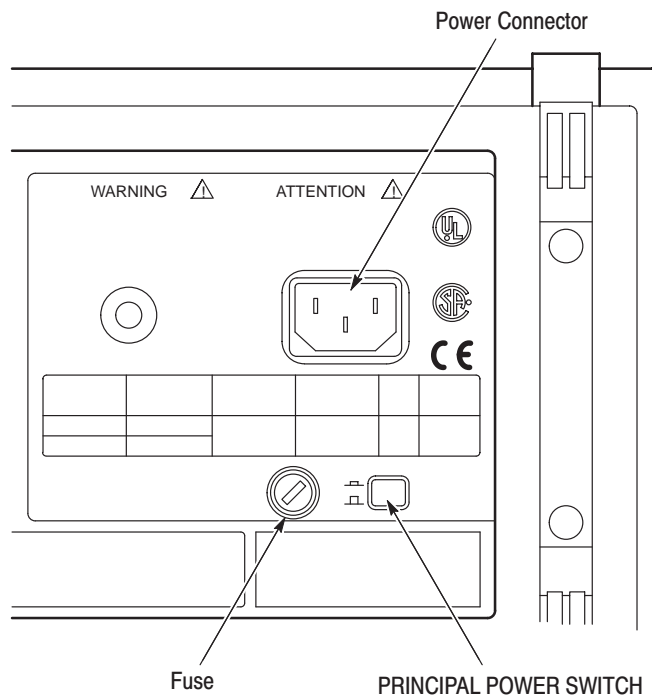

Figure 1-3: Rear panel controls used in start up

8. Press the **ON/STBY** switch (shown in Figure 1-4) on the lower left side of the front panel to switch on the power for this instrument.

Once this instrument is installed, leave the **PRINCIPAL POWER SWITCH** on and use the **ON/STBY** switch as the power switch.

NOTE. *This instrument needs to be warmed up for at least 20 minutes in order to operate at its optimum precision.*

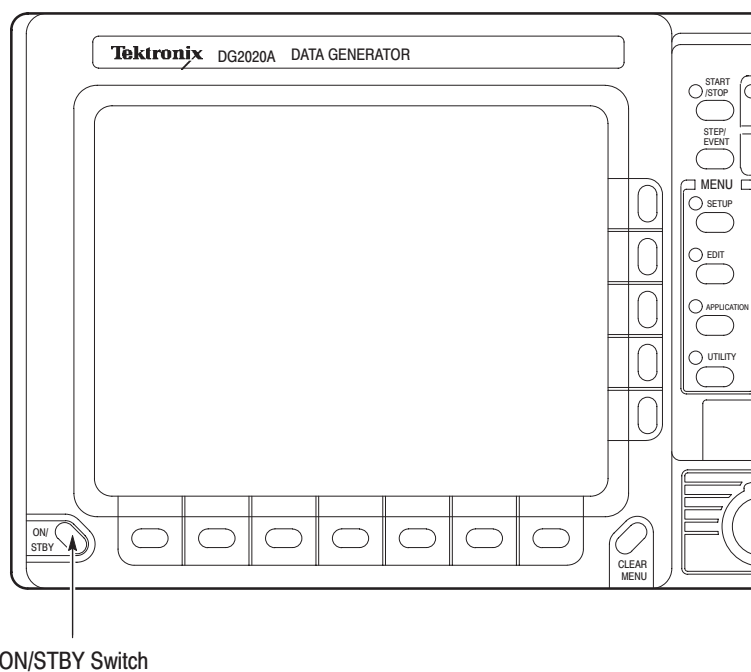

Figure 1-4: ON/STBY switch

Start-up Diagnostics

9. Check the results of the start-up diagnostics.

When the power is applied to this instrument, the start-up diagnostics are automatically run. These diagnostics check whether the instrument is performing within its defined operating characteristics.

If all the diagnostic items are completed without error, the system moves on to the **EDIT** menu.

If an error is detected, **Fail** and the error code are displayed. You can exit this state and operate this instrument, but until the error is corrected, the instrument performance cannot be relied on. To exit the diagnostics system, press any of the buttons. The system moves on to the **EDIT** menu.

If this instrument is exposed to temperatures outside its specified range, and the chassis temperature is inappropriate, an error will occur during the diagnostics when the power is switched on. If this happens, wait until the chassis temperature is appropriate, then switch the power on again.

NOTE. *Contact your local Tektronix Field Office or representative if an error is displayed.*

Power Off

10. Press the **ON/STBY** switch.

Operating Basics

This section provides the following:

- The names of the parts of the instrument and their functions.
- The internal structure and operating principles of the DG2020A. This is an overview of the hardware.
- Operations commonly performed on the instrument and how to enter numbers.
- Simple examples showing how to create pattern data and output them. These examples are designed to help you gain a basic understanding of the instrument.

Functional Overview

This section describes the terminology and functions of the DG2020A front, side, and rear panel controls. This section also describes the Pod front and rear panel controls. The terminology and content of representative screen displays are also found in this section.

Front Panel

Figure 2-1 shows the layout of the DG2020A front panel. Figure 2-2 describes each front-panel control in detail.

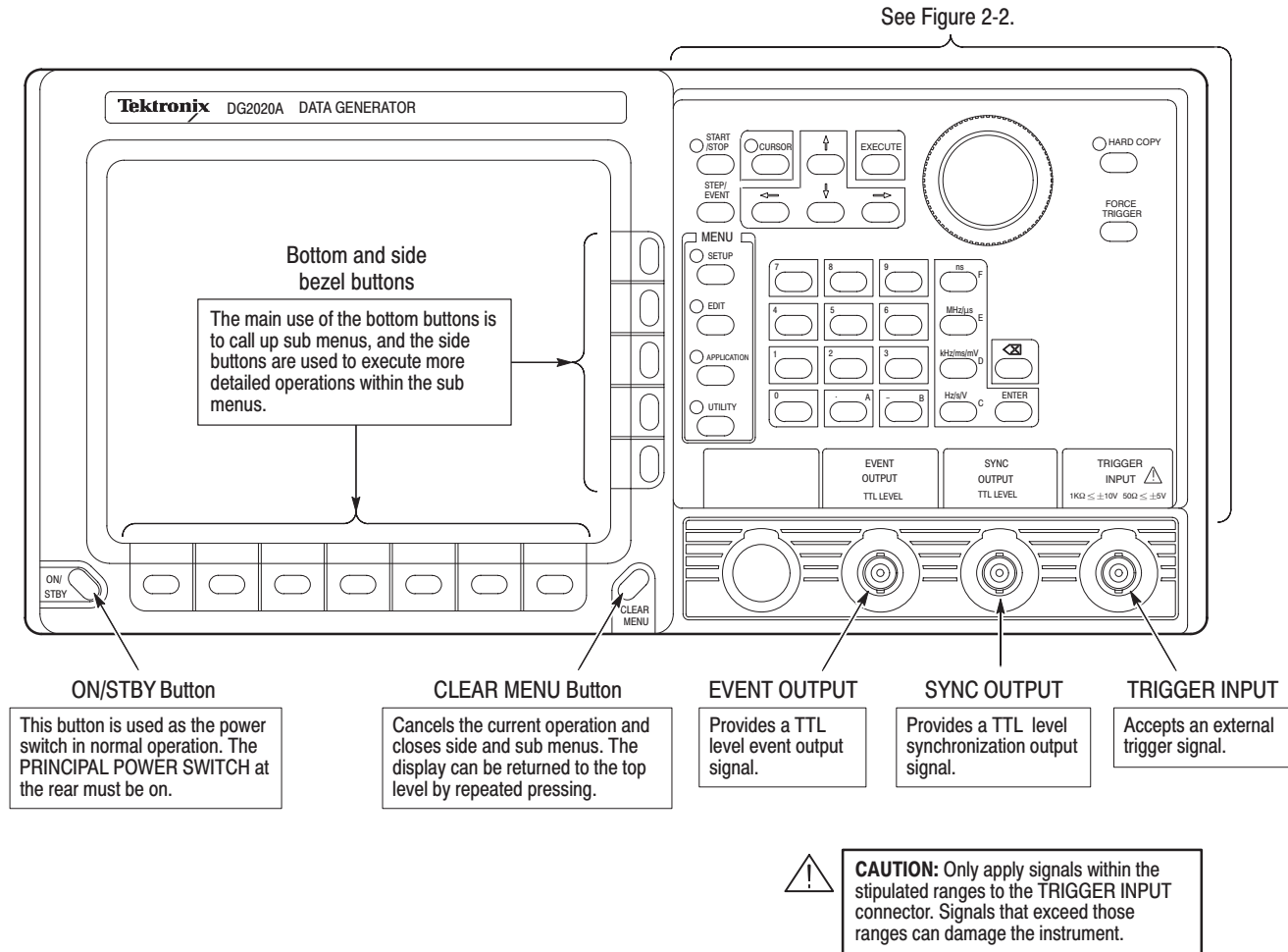

Figure 2-1: Front panel overall view

START/STOP Button

Starts or stops pattern data output. When automatic pattern data update is not used, the pattern data is updated before output is started.

The indicator lights in the output state. It will flash when there is a discrepancy between the output data and the displayed data due to pattern data not being updated.

When automatic pattern data update is specified, the indicator flashes rapidly during data update. It flashes slowly when automatic update is not performed and data update is required.

Refer to *Update* on page 3-75 for update mode.

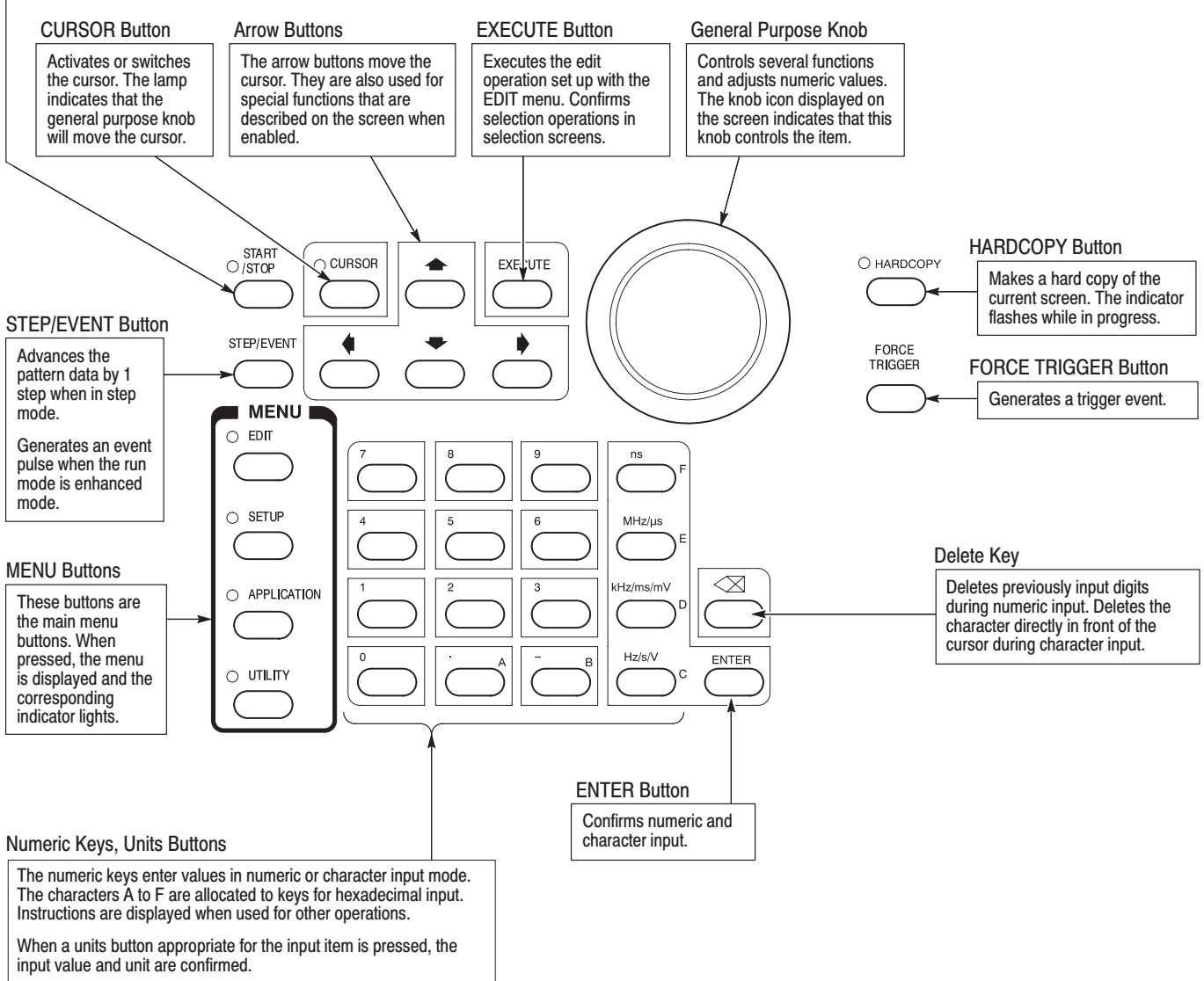

Figure 2-2: Front panel button detail

Rear Panel Figure 2-3 shows the rear panel signal and power connectors.

Pattern Data Output Connector

These connectors are used to connect the output pods and their connection cables. In the standard DG2020A configuration, only the POD A connector is installed.

When option model 01 is installed, POD B is added. When option model 02 is installed, POD B and POD C are added.

IEEE STD 488 Connector

This is a GPIB connector for remote computer control through an IEEE 488 standard parallel interface.

Power Connector

Connect the provided power cable to this connector.

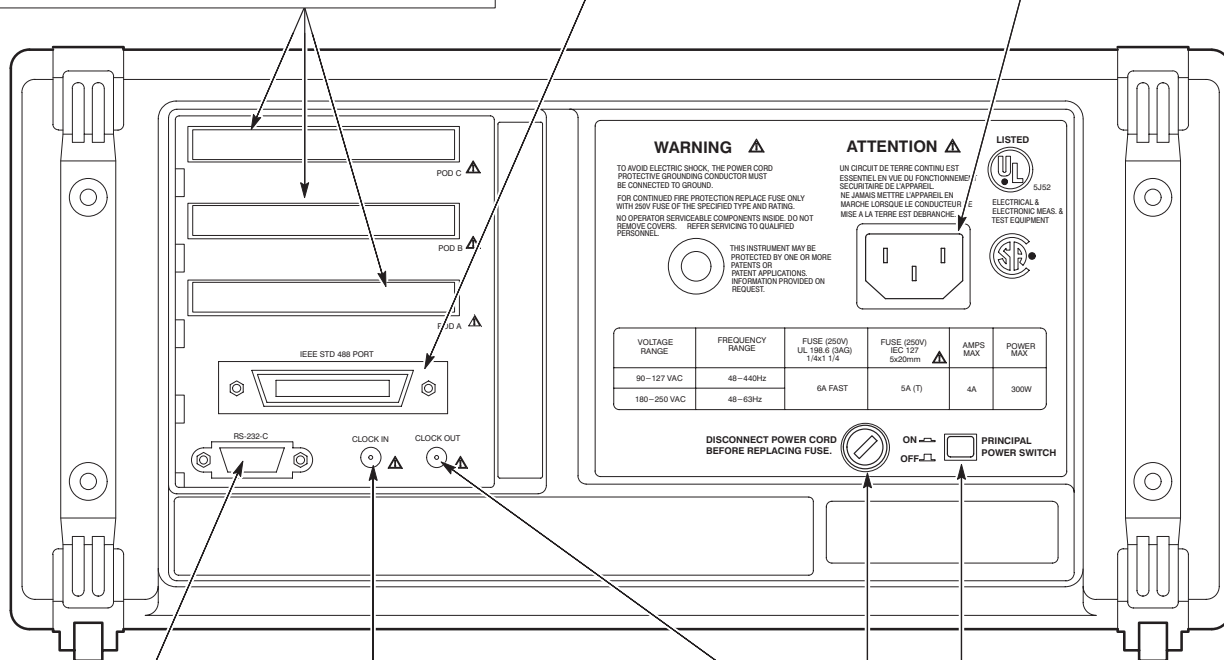

RS-232-Connector

The RS-232-C connector is used for remote computer control over a serial interface.

CLOCK IN Connector



CAUTION: Only apply signals within the stipulated range to the CLOCK IN connector. Voltages in excess of the stipulated range can damage the DG2020A.

Refer to Specifications on page A-4 for proper input levels.

CLOCK OUT Connector



CAUTION: Do not apply external voltages to the CLOCK OUT connector. Applying external voltages can damage the DG2020A.

Refer to Specifications on page A-3 for output levels.

PRINCIPAL POWER SWITCH

This switch applies power to the standby circuit. In addition to this switch being on, the front panel ON/STBY switch must also be turned on.

Power Supply Fuse Holder

The same 6A fast-blow fuse is used for both 115V and 230V systems.

Figure 2-3: Rear panel

Floppy Disk Drive

Figure 2-4 shows the floppy disk drive controls and indicators. The floppy disk drive is located on the right side of the DG2020A chassis. You use the floppy disk drive to save and recall instrument pattern and setting data.



CAUTION. Do not press the eject button while the DG2020A is writing to the floppy disk. Doing so can cause data corruption on the floppy disk.

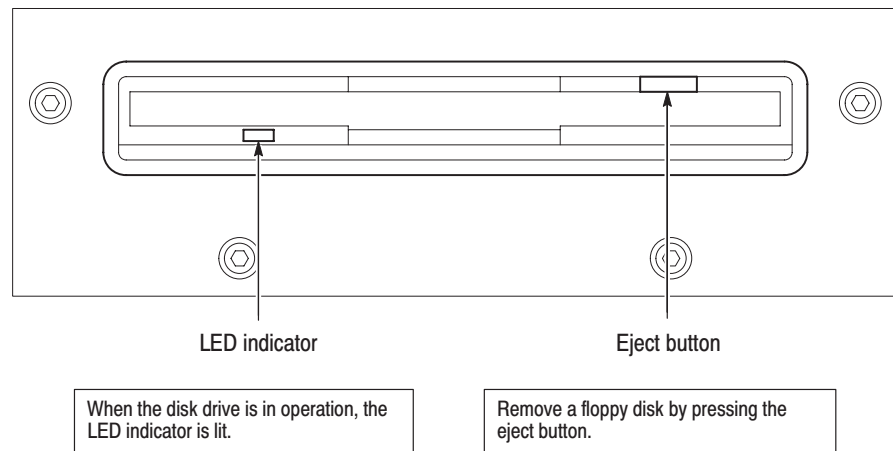

Figure 2-4: Floppy disk drive

Display Elements

Figure 2-5 shows the display elements, including bottom and side menus, work area, status lines, and so on. Also shown are a popup menu and message box. Table 2-1 describes each element in detail.

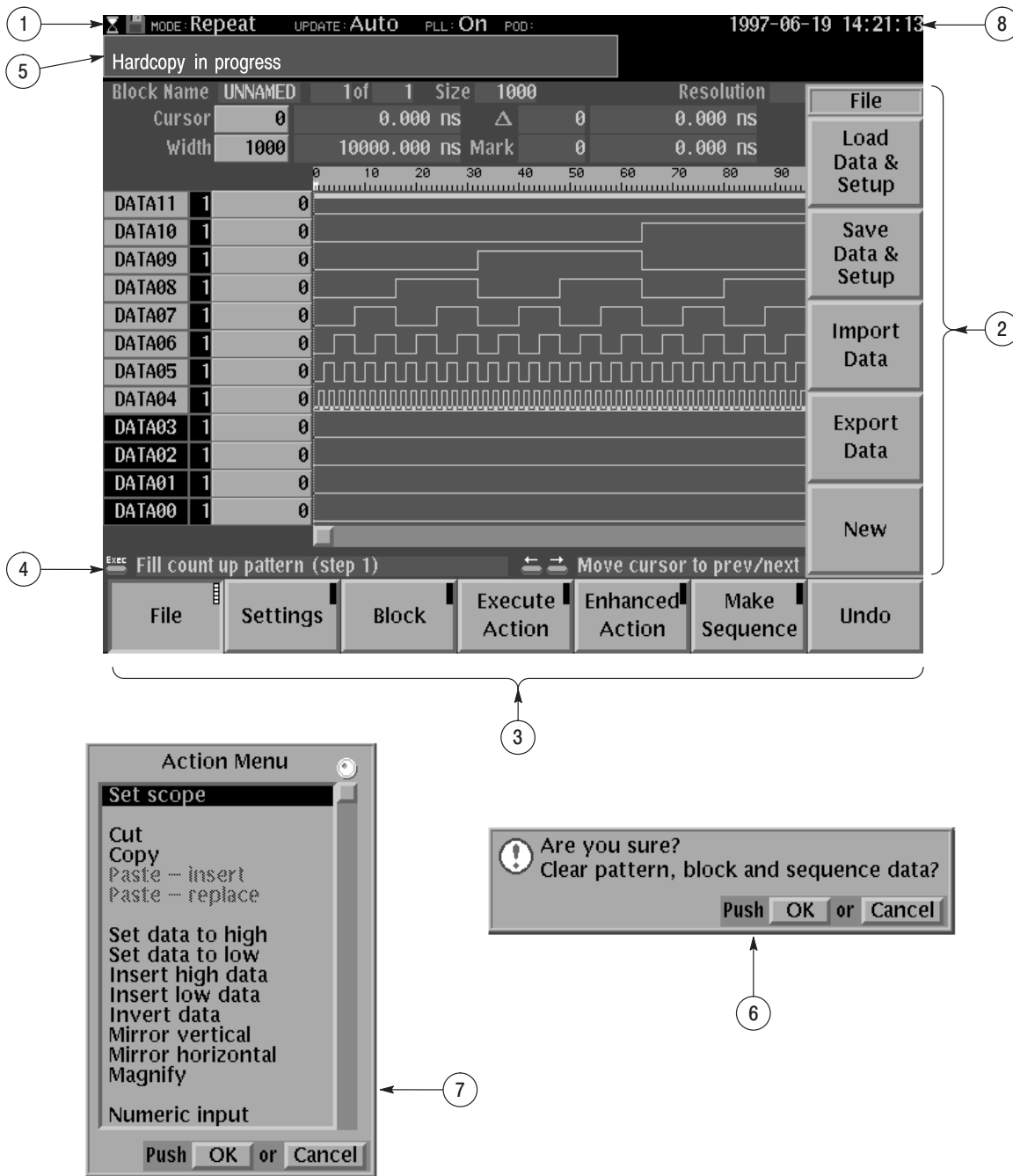

Figure 2-5: Display elements

Table 2-1: DG2030 display elements

Figure number	Label	Description	Page
1	Status area	<p>Displays the current status of the instrument. This status line is always displayed, whichever menu is displayed. The status line displays the following four items.</p> <p>MODE: Displays the run mode in which pattern data will be output.</p> <p>UPDATE: Displays the update method for pattern data output when data is updated.</p> <p>PLL: Displays whether or not the PLL circuit is used as the internal oscillator circuit.</p> <p>POD: Displays the configuration of pods attached to the instrument.</p> <p>In addition, there is also a disk icon that indicates whether or not a floppy disk is inserted in the disk drive. A clock icon may also be displayed at the left end of the status line. When this icon is displayed, the instrument is busy with internal processing and cannot accept other inputs.</p>	<p>3-73</p> <p>3-75</p> <p>3-78</p>
2	Date and Time display area	The date and time display can be turned on or off using the UTILITY menu.	3-87
3	Side menu	Related side menu items are displayed here when a bottom menu item is selected. The topmost entry in the side menu displays either a label representing the side menu or the operation name for the confirmed item.	
4	Bottom menu	When one of the buttons in the menu section is pressed, the corresponding bottom menu is displayed. When a bottom menu item is selected the corresponding side menu is displayed. Selecting the same bottom menu item again closes the side menu.	
5	Button function description area	Displays descriptions of the functions of the front panel buttons.	
6	Message display area	Displays messages that report on the current processing state. This area can be also used by remote commands to display user messages.	
7	Popup message box	When required, the instrument temporarily displays a window at the center of the screen to display a warning or question for the user.	
8	Popup menu	The instrument sometimes displays a pop-up menu when a bottom menu or side menu item is selected. Enter a numeric value or select an item using either the general purpose knob or the front panel buttons.	

P3410 Front and Rear Panels

Figure 2-6 shows the layout of the P3410 front and rear panel.

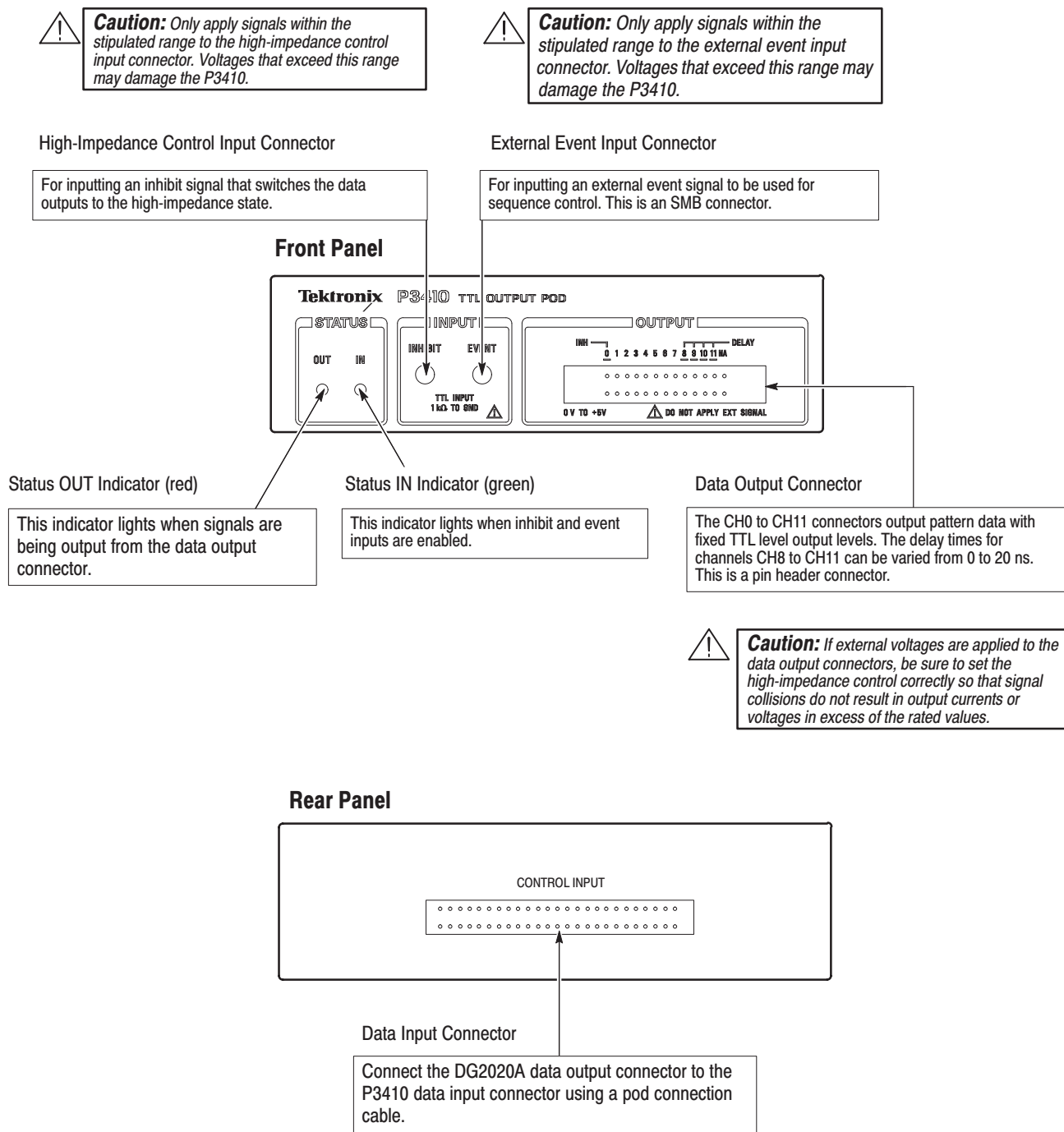

Figure 2-6: P3410 front panel and rear panel

P3420 Front and Rear Panels

Figure 2-7 shows the layout of the P3420 front and rear panels.

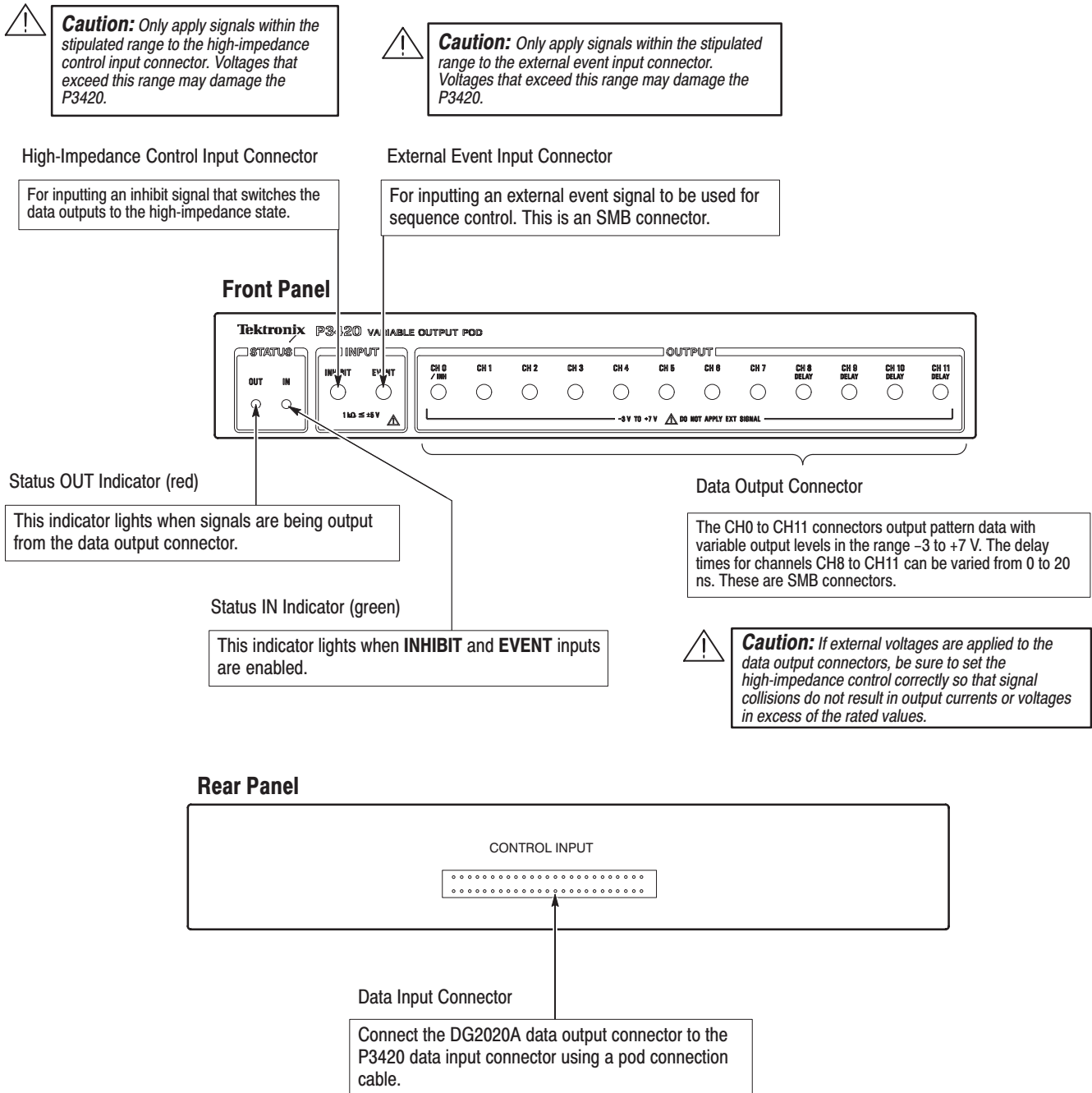

Figure 2-7: P3420 front panel and rear panel

Internal Structure and Operating Principles

This section presents an overview of the DG2020A hardware, data structures, and operating modes to allow you to take full advantage of the DG2020A.

Basic Hardware Structure

Figure 2-8 shows the main hardware blocks that make up the instrument. This section describes these hardware blocks to provide the background knowledge necessary to use the instrument effectively.

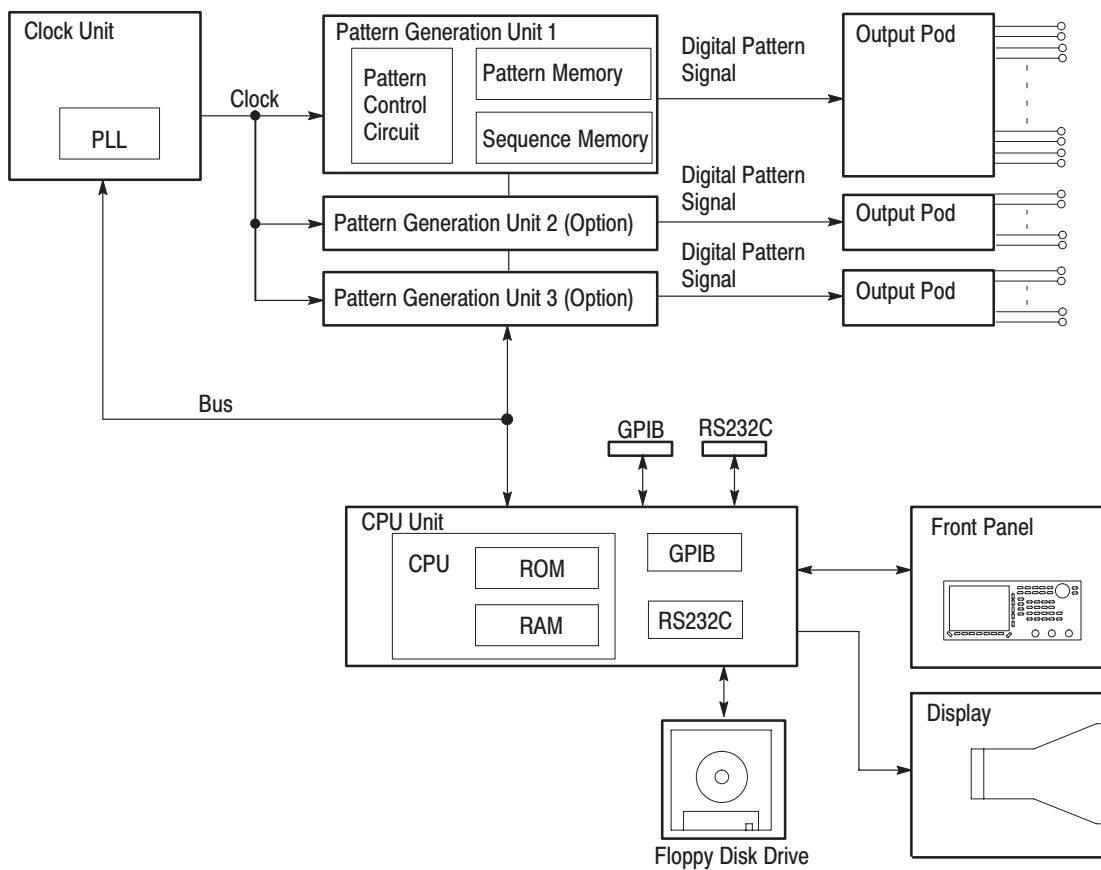

Figure 2-8: Hardware block diagram

CPU Unit The CPU unit controls the whole instrument. The CPU unit includes ROM, RAM, and an I/O interface.

ROM is a memory that holds the program code that implements all the supported functions. The contents of this memory is loaded at the factory.

RAM is a memory that holds a variety of information required by the CPU. The contents of RAM change according to the instrument's operating state. Since the contents of RAM are retained by a built-in battery even when the instrument is turned off, the main instrument settings will still be in effect the next time the instrument is turned on. The pattern data memory and the sequence data memory, which are described later as a conceptual data model, are actually stored in one section of this RAM.

External interfaces include GPIB and RS-232-C interfaces for remote control, a floppy disk drive controller, and a user interface consisting of the display and the front panel.

Pattern Generation Unit The pattern generation unit generates digital pattern signals based on the pattern data and sequence data set up by the user. This unit includes a pattern control circuit, pattern memory, and sequence memory.

The pattern control circuit is the heart of this instrument's fast and flexible digital signal generation function, and is a complex digital circuit that operates at an exceptionally high speed. Pattern memory and sequence memory are high-speed memories that hold the pattern data and sequence data, which are described later. These memories supply pattern data to the pattern control circuit.

The digital signals output by the pattern generation unit are supplied to output pods, which are housed in a separate chassis. A single pattern generation unit handles the signals for 12 channels. The optional 24- and 36-channel configurations incorporate two and three pattern generation units, respectively.

Clock Unit The clock unit generates the clock signals that generate the data patterns. It also handles detection of, and synchronization with, external trigger signals.

The user can select whether or not the PLL circuit is used in clock signal generation. When the PLL circuit is used (PLL on), the clock unit generates a clock signal synchronized to an internal crystal oscillator. This provides an output with excellent frequency precision. When the PLL circuit is not used (PLL off), the clock unit can generate a clock output synchronized with an external trigger signal, although the frequency precision is lower. The PLL circuit can be turned on or off depending on the application.

Output Pod There are two output pod types: the P3410 (TTL level), which provides fixed output levels, and the P3420, which provides variable output levels. These pods provide digital signals to the device under test.

The output pods level-convert the pattern signals from the pattern generation unit to output signals appropriate for the device under test. They also handle fine adjustment of specific bit timing.

The fixed output level model uses TTL level output buffers for signal output. The variable level model uses variable output level drivers.

Inhibit Function

The pods support a function that sets their outputs to the high-impedance state. This function is set up using the **Change Inhibit Control** sub-menu in the **SETUP** menu **Pod Assign** item. For channels CH1 to CH11, the CH0 signal, the external inhibit input signal, or the logical OR of those two signals can be selected as the high-impedance control signal, and the external inhibit input signal can be selected for CH0 high-impedance control.

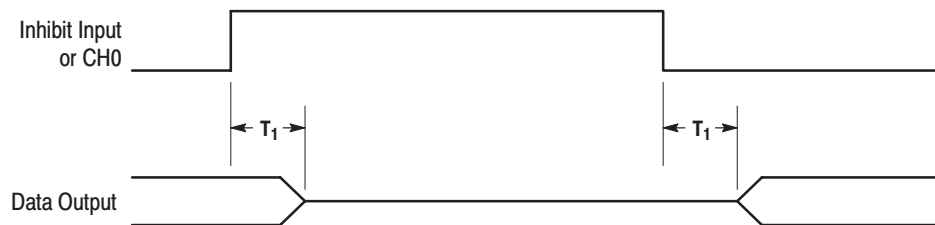

T₁: The delay time from an inhibit input or a CH0 signal until the corresponding data output goes to the high-impedance state, or the delay from the high-impedance state until high- or low-level data is available. Refer to Table A-3 Electrical Characteristics (typical) on page A-7 for more information.

Figure 2-9: Inhibit operation timing

Display and Front Panel

The display and front panel implement the user interface.

The display is a 16-level monochrome 640 × 480 pixel CRT. The front panel consists of menu buttons, numeric keys, bezel buttons, a general-purpose knob for changing numeric values and item selection, and several signal output connectors.

Data Structure Basics

To make full and efficient use of the DG2020A, in addition to understanding the hardware, you also need to understand the basic structure of the data handled by the instrument. This section presents an overview of the pattern data, setup data, and sequence data.

Pattern Data The pattern data is the basic data that defines the digital signals to be output. The pattern data is a collection of 36-bit words. The total number of words is called the memory size. The memory size can be any value from a minimum of 64 words to a maximum of 64K words (65,536).

Setup Data As described below, there are a large number of settings that define data structures and relationships between data items and that specify output pod states and other parameters. These settings are collectively referred to as the setup data. Since this data is intimately related to the pattern data, it is handled together with the pattern data in operations such as saving to a floppy disk.

Although each bit in the pattern data can be defined independently, it is easier to edit and display data if multiple bits are collected and handled as a single group. Any set of bits can be assigned as a group. However, they must be next to each other. For example, D00 – D03 can be assigned a group, but D00, D02, and D05 can not.

Pattern data can be divided into blocks. Blocks are divided by setting delimiters called block delimiters. Block delimiters are set in word units. Sequences, which are described later, control data output in block units.

Once pattern data has been transferred to the pattern memory in the pattern generation unit hardware it can actually be output as digital signals. Pattern memory consists of 12-bit words, with the 12 bits in a one-to-one correspondence with the 12 output channels in a pod. Here, only part of the 36 bits of pattern data is actually used by each pod. The definition of the relationship between pattern data bits and pattern memory bits is called pod allocation.

The pattern data to pattern memory transfer operation is either performed automatically each time the data is modified, or the user can manually cause the transfer to occur. This is called the data update mode, and it can be selected by the user.

The setup data includes a wide range of settings, including output pod voltage levels, delay times, and high impedance control and clock frequency and PLL settings in addition to the definitions described here.

Sequence Data The sequence data is a program that specifies the order in which the pattern data is output. The sequence data is used to set up operations such as iteratively putting out blocks of pattern data for a specified number of times, and jumping to a specified block when an external event occurs. Sequences allow long patterns to be set up without preparing large quantities of data. Sequence data is transferred to the pattern generation unit sequence memory, and specifies the operation of the pattern control circuit. Using the run mode, which is described in detail later, the you can select whether all the sequence data is valid or whether enhanced mode settings such as event jumps in the sequence are ignored.

Technical Terms Table 2-2 lists the data structure related technical terms that appear frequently in the operating procedure descriptions. Figure 2-10 shows the usage of these terms graphically.

Table 2-2: Data structure terms

Term	Meaning
Pattern data	Basic data for patterns, consisting of 36-bit words
Memory size	The number of pattern data words (64 to 64K words)
Group allocation	Definitions of pattern data bit combinations
Block delimiter	Delimiter that defines sections of pattern data
Block division	Pattern data division by block delimiters
Pod allocation	Definition of the correspondence relationship between pattern data and output bits
Setup data	Settings for the above items
Sequence data	Pattern output sequence program

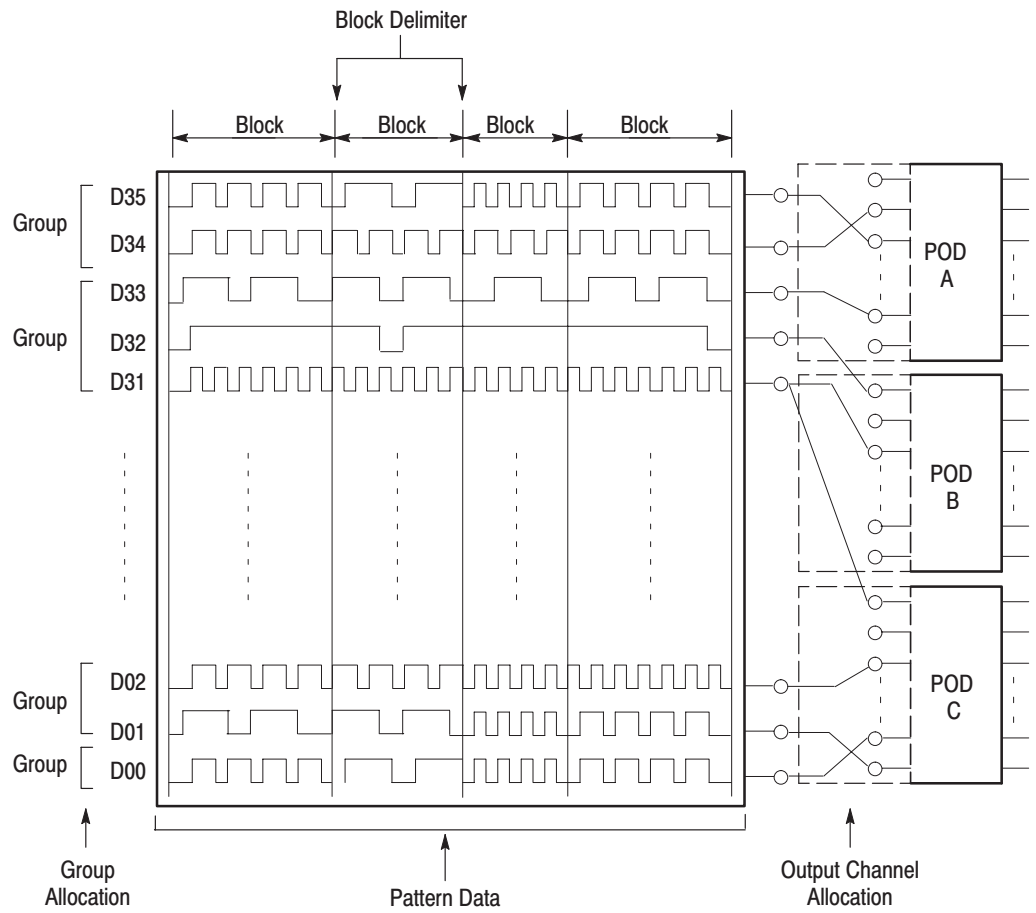

Figure 2-10: Data structure image

Operating Modes Overview

Run Modes In the run modes, pattern output is controlled by the pattern generation unit’s pattern control circuit. The DG2020A supports four run modes: repeat, single, step, and enhanced. These run modes are specified with the **SETUP Run Mode** menu. Table 2-3 provides functional information for each mode.

Table 2-3: Run modes

Run mode	Function
Repeat	Repeats the pattern data from the first to last point indefinitely. If a sequence is defined, iterates the output according to that sequence.
Single	Outputs the pattern data once from the first to last point in point order. If a sequence is defined, outputs the pattern once according to that sequence.
Step	Operates identically to repeat mode, except that just one point is output each time the STEP/EVENT button is pressed, .
Enhanced	Same as Repeat with the addition that event jumps and trigger waits are also effective.

The three modes other than enhanced mode ignore the event jump and trigger wait settings.

Update Modes When pattern data or sequence data is created or edited, or the output pod bit allocations are changed, the pattern that is actually output will not be updated unless these new settings are transferred to the pattern generation unit. For doing this, the DG2020A supports two methods: auto and manual. These are called the update modes, and are set up with the **Update** item in the **SETUP Run Mode** menu. Table 2-4 provides functional information for both modes.

Table 2-4: Update modes

Update mode	Function
Auto	Changes are reflected in the hardware as soon as they are entered.
Manual	Changes are reflected in the hardware when specified by the user.

NOTE. *Although the output will be updated reliably in auto mode, the response to edit operations may be slow when there is a large amount of data. In such cases, it is more efficient to perform a number of edit operations, and then update the output data in a single operation in manual mode.*

Basic Menu Operation

This section describes the operations and numeric input methods that are basic to DG2020A operation.

Menu Operations

The instrument's menu system is used for instrument settings, operation, and pattern data output parameter selection. Pressing one of the menu buttons at the center of the instrument's front panel displays one of the menus that forms the basis of DG2020A operation. There are four menu buttons, **EDIT**, **SETUP**, **APPLICATION**, and **UTILITY**. See Figure 2-11.

The menu items displayed on the screen are selected by pressing the corresponding bezel button. The bezel buttons consist of the seven bottom buttons and five side buttons. See Figure 2-11.

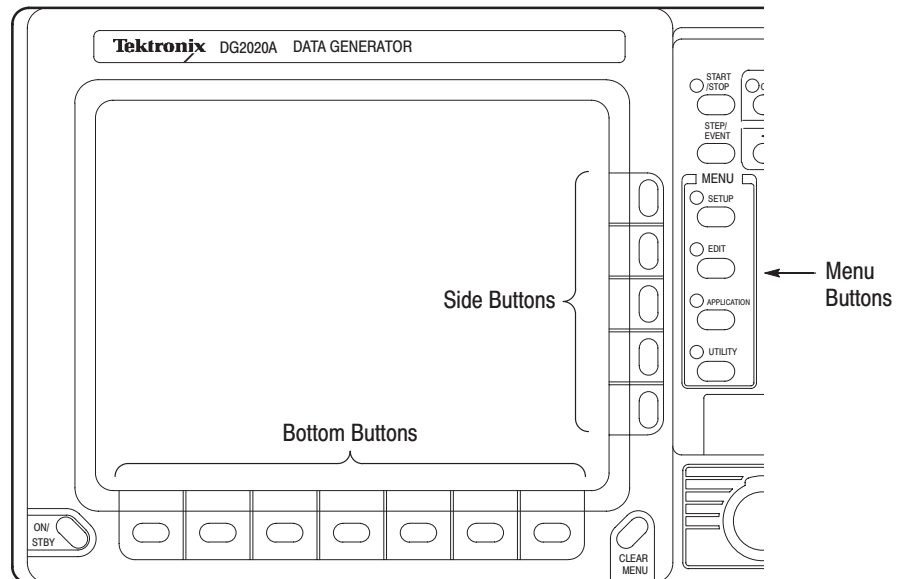

Figure 2-11: Menu buttons and bezel buttons

When the target menu item is selected, the selection items and numeric input entries controlled by that menu are displayed. Items can be selected or numeric values changed using the numeric keys and the general purpose knob.

When a menu item is selected, one of the following operations is performed.

- A lower level menu is invoked.
- An item is selected.
 - The selected item changes each time a bezel button is pressed.
 - A list is displayed and an item is selected from that list.
- Numeric input is enabled.
- The function associated with the menu item is executed as soon as the menu item is selected.

Menu Notation

The following notation is used in this manual to show the order to push instrument buttons:

Front panel menu button → Bottom menu button → [Side menu button or popup menu item]

The menu path starts with a front panel menu button, followed by an arrow (→), and then a bottom menu. The item in parenthesis may be repeated more than once, as needed. For example, **SETUP** → **Output Condition** → **Control Condition** → **Change Inhibit Control** → **Both** → **OK** is executed as follows:

1. Press the **SETUP** button on the front panel.
2. Press the **Output Condition** bottom button.
3. Press the **Control Condition** side button.
4. Press the **Change Inhibit Control** side button.
5. Select **Both** from the popup menu.
6. Press the **OK** side button.



Menu Item Display

Starting with each main menu, the instrument displays bottom, side, and sub menu items according to fixed rules.

Bottom Menu

Bottom menu items display change according to whether items are selected or not, and whether an item is valid or not, as shown in Table 2-5.

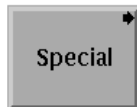
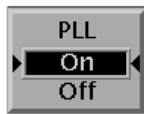



Table 2-5: Bottom menu item display

Menu item	Description
	Menu item in the unselected state. The small box in the upper right corner is black.
	Menu item in the selected state. The small box in the upper right corner is white.
	Menu item that cannot be selected since it is invalid in the current state.

Side and Sub Menus

The menu items that are manipulated with the side buttons, can be classified according to the manipulations they support. These menu items can be differentiated visually as shown in Table 2-6.

Table 2-6: Side and sub menu item display

Menu item	Description	Menu item	Description
	Menu items that execute a function immediately		Menu items that call up sub menus
	Menu items that switch between on and off each time the side button is pressed.		Menu items that allow selections to be made with the general purpose knob
	Menu items that allow numeric values to be set using the numeric keys or the general purpose knob		Menu items that cannot be used in the current instrument state

Numeric Input

General numeric input items can be set using the following methods.

- Input using the numeric keys
- Setting by turning the general purpose knob

This section describes these numeric input methods.

Numeric Input Keys

The numeric keys, the units buttons, the delete key and the **ENTER** key are used for entering numeric values. See Figure 2-12.

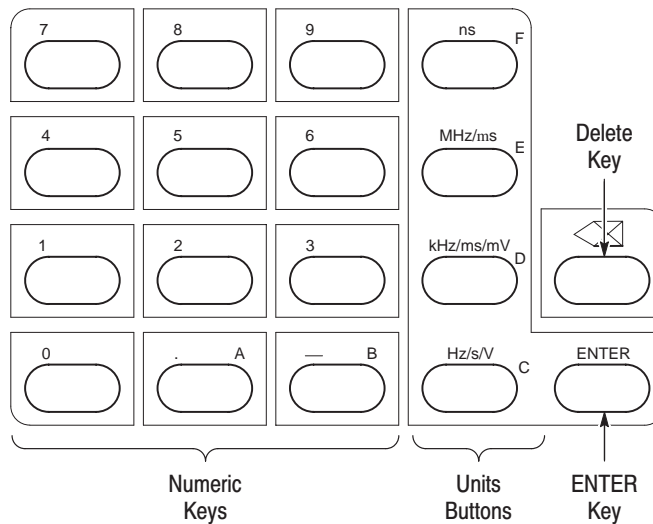

Figure 2-12: Numeric keys, units button, delete key, and enter key

Numeric inputs using the numeric keys

Use the following procedure to input numeric values with the numeric keys, **ENTER** key, and units buttons on the front panel.

1. Press the button for the menu item to be changed.
2. Input the target value using the numeric keys.
3. Press a units button or the **ENTER** key.

Figure 2-13 shows a menu display during numeric input. The asterisk at the left indicates that a value is being input. Press the front panel **ENTER** key to confirm the value and remove the asterisk.

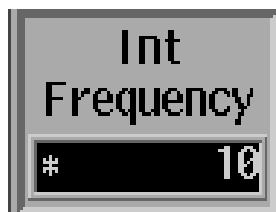

Figure 2-13: Numeric input using the numeric keys

Numeric Input Examples

This example shows how to change the clock frequency to 12.3 Hz when the value before entering the input state was 100.0 Hz. When the **1**, **2**, **.**, **3**, and **ENTER** keys are pressed in that order, the numeric input window changes as shown in Table 2-7.

Table 2-7: Numeric input example

Press keys in this order	Numeric input window display	State of the value
	100 Hz	Pre-numeric input
1	* 1	Numeric input in progress
2	* 12	
.	* 12.	
3	* 12.3	
ENTER	12.3 Hz	Value confirmed

Pressing a units button after a value has been entered confirms both the value and the unit in a single operation. Pressing a units button before entering the input state changes only the unit without changing the value.

If you switch to another menu item after entering a value but without pressing either the **ENTER** key or a units button, the entered value is discarded and the value returns to its previous value. If a value outside the allowable range of a parameter is set, the value will be replaced with the largest or smallest value allowable for that parameter.

Setting Values with the General Purpose Knob

The general purpose knob and the left and right arrow buttons can be used to set values in numeric input windows. The knob icon is displayed close to the window to show that setting using the knob is possible. The general purpose knob is used to increase or decrease the value of the digit indicated by the underscore. Rotating the knob to the left decreases the value and rotating it to the right increases the value.

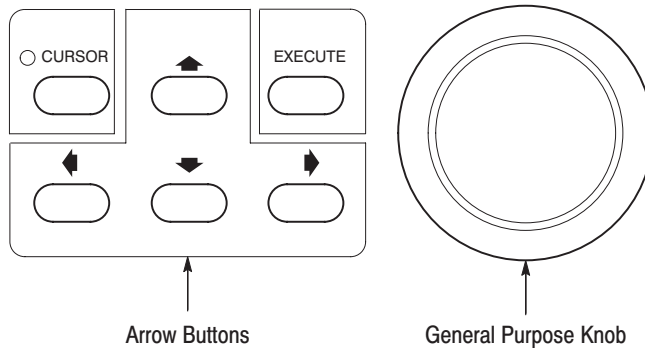

Figure 2-14: General purpose knob and arrow buttons

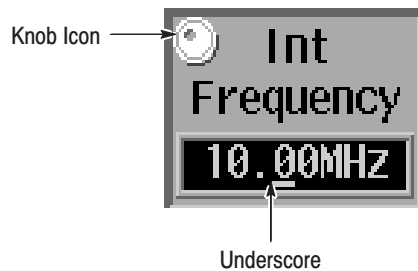

Figure 2-15: Knob icon and underscore

You do not need to use the front panel **ENTER** key to confirm a value when using the general purpose knob to change a value. The input value is confirmed automatically without pressing the **ENTER** key.

Use the following procedure to change a value with the general purpose knob.

1. Press the button for the menu item to be changed.
2. Use the left and right arrow buttons to set the digit to be modified.

The front panel arrow buttons control the amount of change that can be achieved with the general purpose knob. Pressing the ◀ button moves the underscore one digit to the left and thus multiplies the effect of turning the general purpose knob by ten. Inversely, pressing the ▶ button moves the underscore one digit to the right and reduces the effect of turning the general purpose knob by a factor of ten.

3. Change the value by turning the general purpose knob.

Pattern Data Display Format

You can display pattern data in one of three formats: timing display, table display, and binary display. Use the **EDIT** → **Settings** item to select the display format. Figures 2-16 through 2-18 show the three display formats.

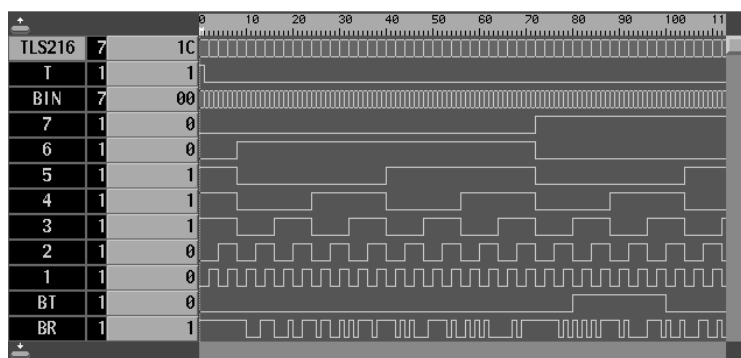

Figure 2-16: Timing display format

Time	Signal	T	BIN	7	6	5	4
0	0	1C	1	00	0	0	1
		1C	0	01	0	0	1
		1D	0	02	0	0	1
		1D	0	03	0	0	1
		1E	0	04	0	0	1
		1E	0	05	0	0	1
		1F	0	06	0	0	1
		1F	0	07	0	0	1
		20	0	08	0	1	0
		20	0	09	0	1	0
10		21	0	0A	0	1	0
		21	0	0B	0	1	0
		22	0	0C	0	1	0
		22	0	0D	0	1	0
		23	0	0E	0	1	0

Figure 2-17: Table display format

Time	Bit 15	Bit 14	Bit 13	Bit 12	Bit 11	Bit 10	Bit 9	Bit 8	Bit 7	Bit 6	Bit 5	Bit 4	Bit 3	Bit 2	Bit 1	Bit 0
0	0	0	1	1	0	0	0	0	0	0	0	0	0	0	0	1
	0	0	1	1	0	0	0	0	0	0	0	0	0	0	0	1
	0	0	1	1	0	0	0	0	0	1	0	0	0	0	0	1
	0	0	1	1	0	0	0	0	0	1	0	0	0	0	0	1
	0	0	1	1	0	0	0	0	0	1	0	0	0	0	0	1
	0	0	1	1	0	0	0	0	0	1	0	0	0	0	0	1
	0	0	1	1	0	0	0	0	0	1	0	0	0	0	0	1
	0	0	1	1	0	0	0	0	0	1	0	0	0	0	0	1
	0	0	1	1	0	0	0	0	0	1	0	0	0	0	0	1
	0	0	1	1	0	0	0	0	0	1	0	0	0	0	0	1
10	0	1	0	0	0	0	0	1	0	0	0	0	0	0	0	1
	0	1	0	0	0	0	0	1	0	0	0	0	0	0	0	1
	0	1	0	0	0	0	0	1	0	0	0	0	0	0	0	1
	0	1	0	0	0	0	0	1	0	0	0	0	0	0	0	1
	0	1	0	0	0	0	0	1	0	0	0	0	0	0	0	1
	0	1	0	0	0	0	0	1	0	0	0	0	0	0	0	1
	0	1	0	0	0	0	0	1	0	0	0	0	0	0	0	1

Figure 2-18: Binary display format

The Timing display format shows the waveform patterns for the data graphically with the time axis in the horizontal direction. The Timing display shows the data so that data transitions and the relationships between bits can be easily grasped.

The Table display format shows the data for each clock as numeric values for each group.

The Binary display format shows the data bit states for each clock as 0 or 1. This is the basic display for digital signals, and is an appropriate format for handling data in bit units. If no groups are defined, data can only be displayed in binary format.

Note that the values of the grouped data are displayed with the bits that form those groups converted to hexadecimal in the timing display and table display formats. Displaying multiple bits grouped in this manner is called bus display. The binary display format displays each bit independently, regardless of the group definitions.

While the same output results whichever display format is selected, these display formats have the following distinguishing features. Use these different formats according to your needs.

- Timing display. Displays the data so that data transitions and the relationships between bits can be easily grasped.
- Table display. Displays data divided into groups precisely and briefly.
- Binary display. This is the basic display for digital signals, and is an appropriate format for handling data in bit units.

If no groups are defined, data can only be displayed in the binary format.

Edit Operations

The DG2020A user interface eliminates problems found in other interface schemes. Most user interface schemes that adopt graphical menu items execute editing operations as soon as that operation is selected from a menu. This scheme has the problem that operation becomes inefficient if the same operation must be repeated many times. Another problem is that the screen area is not large enough to make selections from the editing operations menu items while checking the data being edited on the screen. The DG2020A's user interface was designed with these points in mind. The DG2020A pattern data editing functions separates the selection and execution of editing operation.

The different editing operations are selected from the **EDIT Execute Action** menu. Pressing the front panel **EXECUTE** button executes the selected operation. Editing can be accomplished quickly by using the general purpose knob and the **CURSOR** button to move the cursor and then pressing the **EXECUTE** button. Figure 2-19 shows the procedure used to select the Invert data editing operation and then invert data bits at three locations.

1 Select Invert data.

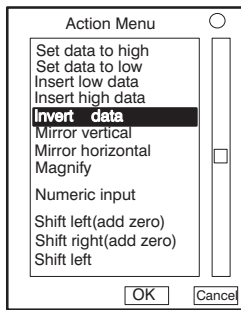

Execute Action menu

Move the cursor to the numbered positions.
At each position, press the **EXECUTE** button
to take the selected action.

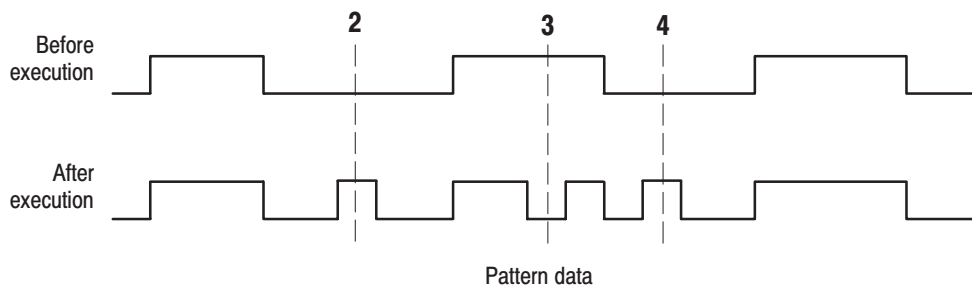

Figure 2-19: Pattern data editing procedure

Area and Point Cursors

When editing pattern data, there are two types of cursors used for indicating the data that will be the object of the edit operation. The type of cursor-used depends on whether a particular point in the data must be indicated, or an area of data must be indicated.

Each type of cursor has a different form. They are called the point cursor and the area cursor. Figure 2-20 shows these cursors.

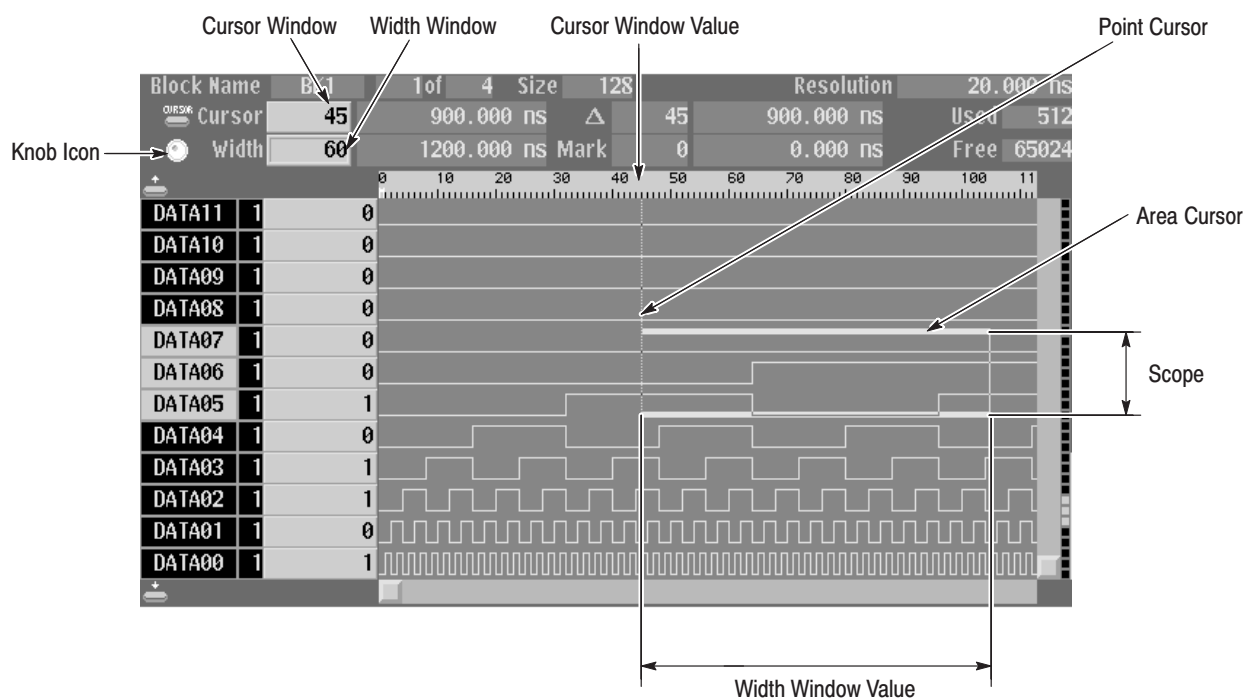

Figure 2-20: Cursor display in editing operations

The area cursor is used in the copy operation. In this operation, the data in the area specified by the area cursor is copied to the edit buffer memory. The paste operation is an example where the point cursor is used. In this operation, data that was previously loaded into the edit buffer memory is copied into pattern memory at the point specified by the point cursor.

The area cursor's area is determined by a combination of an area origin (as defined by a data group and a sample point position), the number of points (which corresponds to the width of the area) and the scope (which corresponds to the height of the area). The origin data group is set with the up and down arrow buttons. The origin sample point is displayed in the **CURSOR** window at the upper left of the screen in the same way as the point cursor is displayed, and can be manipulated in the same way as the point cursor.

The width of the area cursor is displayed in the Width window, and can be set with the general purpose knob or numeric keys when the knob icon has been moved to the Width window using the **CURSOR** button. Use the **EDIT** → **Execute Action** → **Set Scope** item to set the area cursor height.

The position of the point cursor is determined by a data group and a sample point. The data group is set with the vertical arrow buttons. The sample point position is displayed in the **CURSOR** window at the upper left of the screen. It can be set with the general purpose knob or the numeric keys when the knob icon has been moved to the Cursor window with the front panel **CURSOR** button.

Text Input

Text input is required to enter the names for data groups, data blocks, floppy disk files, and other items. When such input is required, the instrument pops up the window shown in Figure 2-21.

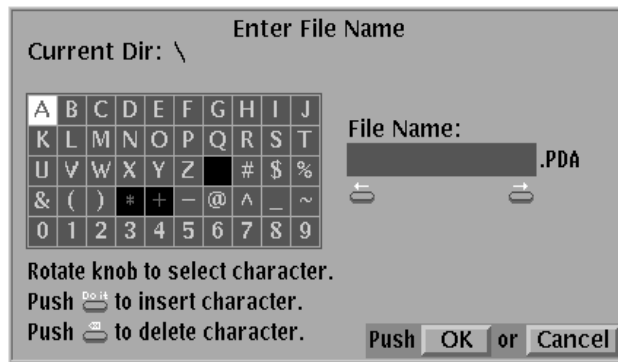

Figure 2-21: Character input menu

Initially, the instrument displays a default string, usually the original string for the item. Use the side menu **Clear String** button to erase this default string. A character is selected by using the arrow buttons or the general purpose knob to move the reverse-video cursor to the desired character in the letter/digit matrix, and pressing the **EXECUTE** button. Incorrect input can be erased with the delete key. The position where the character will be inserted is indicated with an underscore. Use the left and right arrow buttons to change the position of the underscore.

When the required characters have all been selected by this operation, complete the operation by pressing the **OK** button on the side menu. To cancel the operations press **Cancel** on the side menu. This returns the display to the previous menu.

Pop up Confirmation Windows

The instrument displays a message box that prompts you to confirm operations that would be difficult to recover. Figure 2-22 shows the file deletion confirmation message box. Press the side menu **OK** button to execute the operation displayed in the box. Press **Cancel** to cancel the operation and return to the state prior to selecting the current menu.

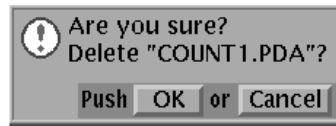
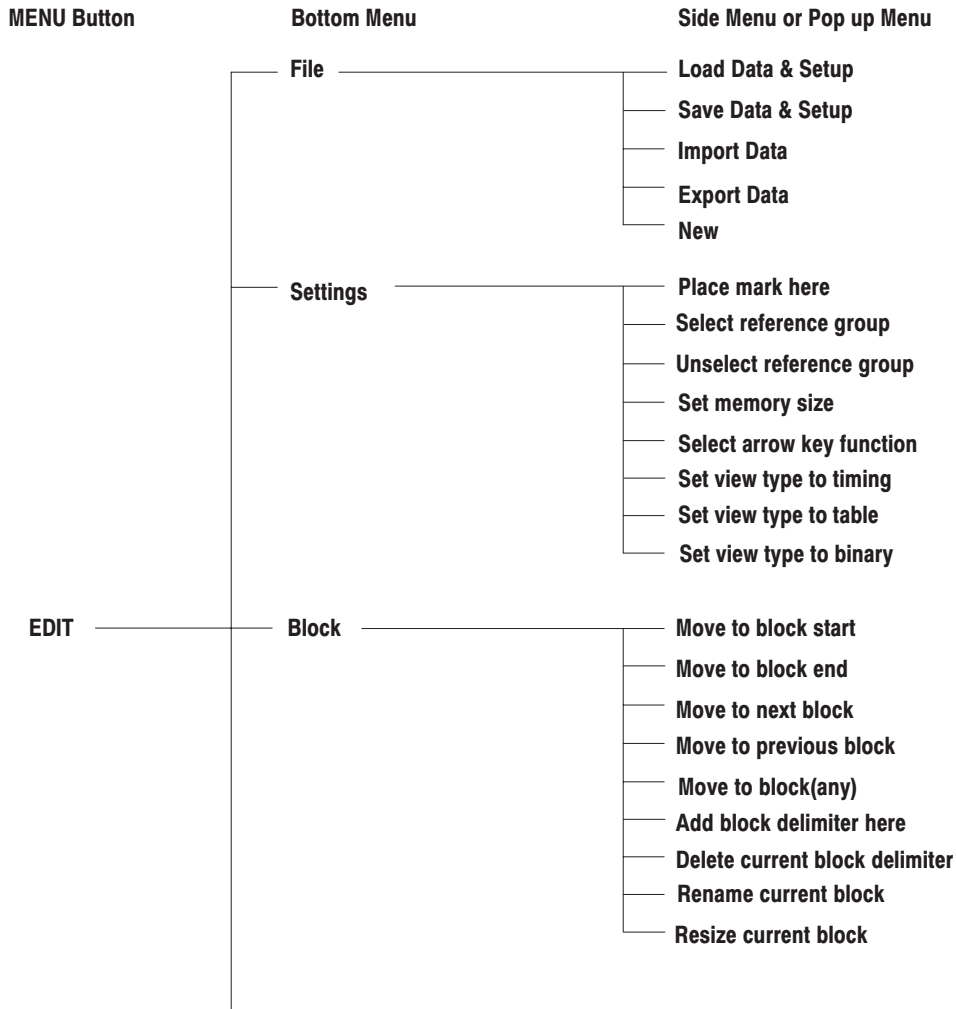

Figure 2-22: Popup confirmation window

Menu Trees

Menu trees are shown for the **EDIT**, **SETUP**, and **UTILITY** menus.

Edit Menu Tree



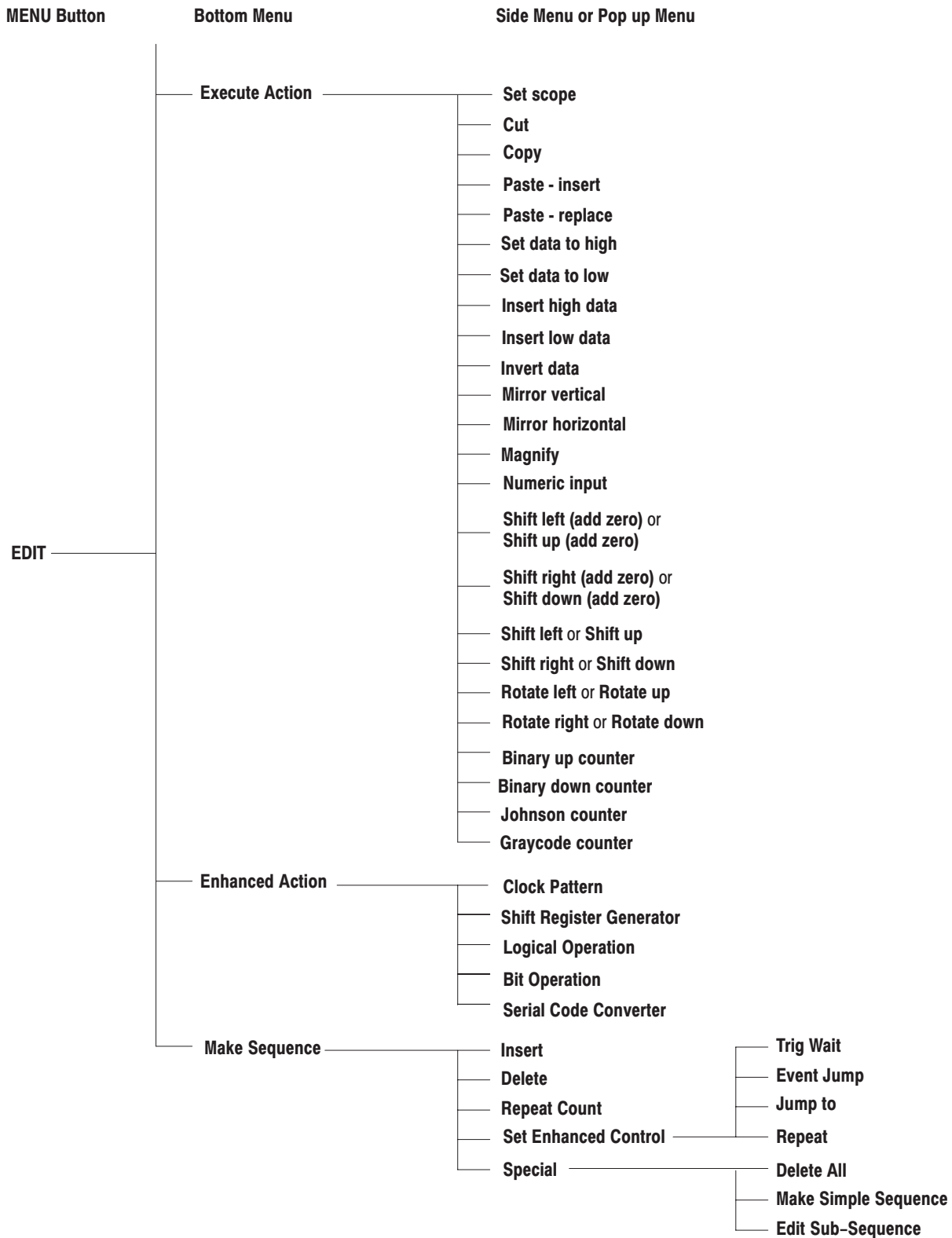

Setup Menu Tree

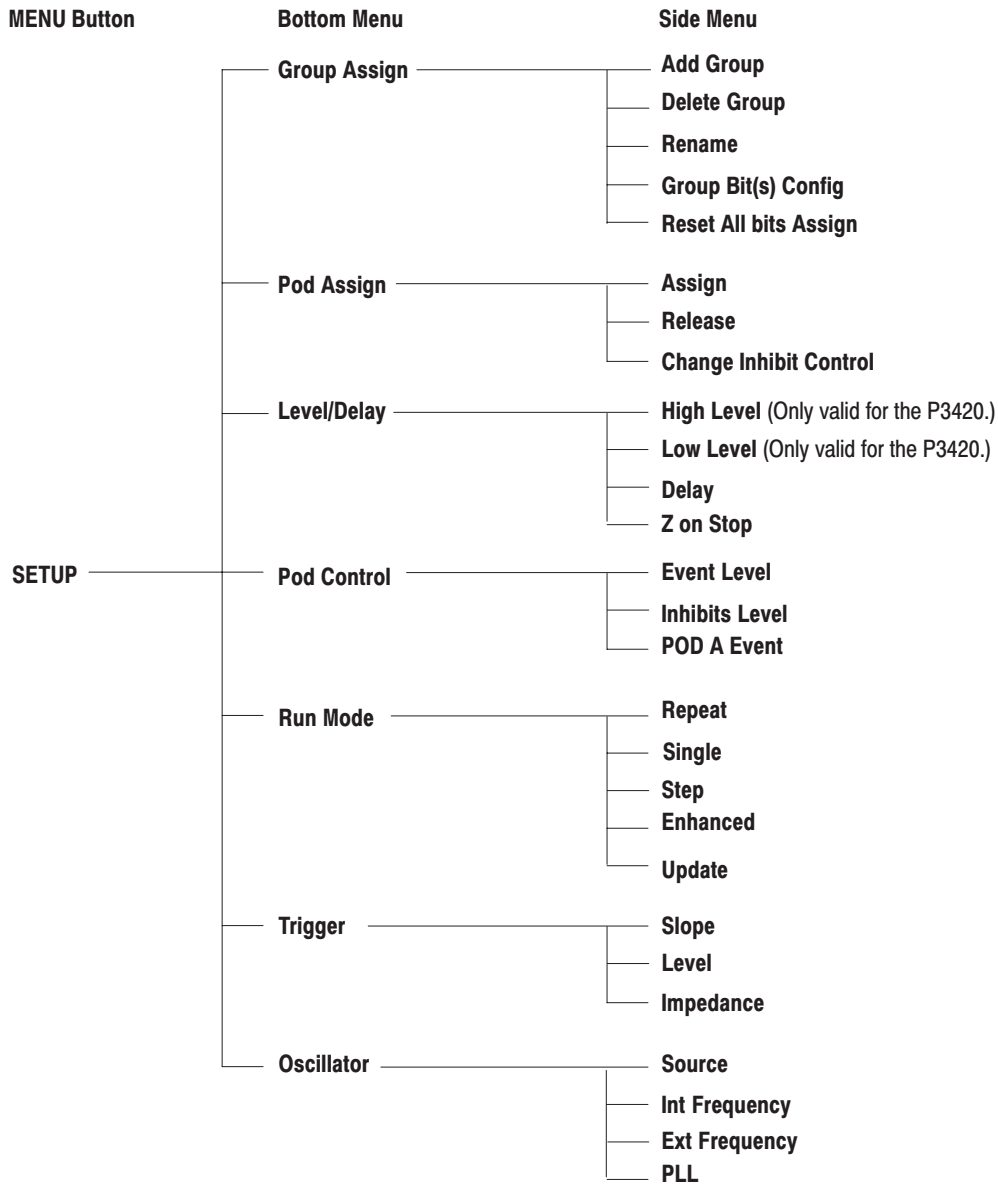

Utility Menu Tree

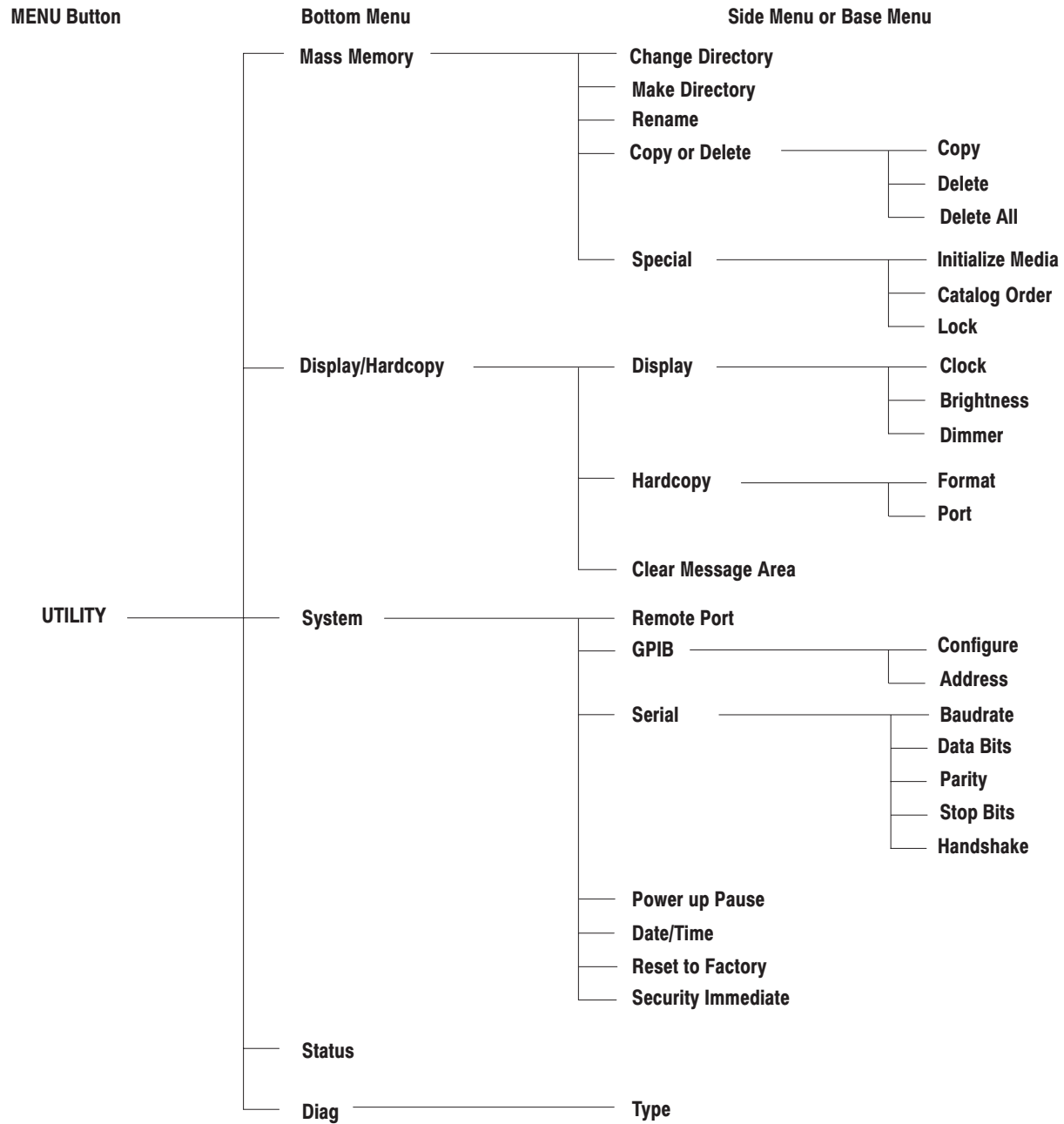

Basic Operation Examples

This chapter describes DG2020A operating procedures from pattern signal creation through output by presenting simple examples. Following these procedures is a good way for new users to get an overview of the instrument's operation. This section presents the following four sample procedures.

1. Creating a Pattern and Storing it in a File
2. Loading and Editing a Pattern Stored in a File
3. Setting up Signal Output
4. Creating a Sequence

Refer to the menu descriptions in section 3 for detailed explanations of the functions used in these procedures.

NOTE. *These examples do not cover all the features and functions of the DG2020A. They are intended only to introduce the operations required to execute the instrument's basic functions.*

Required Equipment

The following equipment is required for examples 1 through 4.

- A formatted floppy disk (2HD, 1.44 MB)
- A digital storage oscilloscope (A Tektronix TDS-Series oscilloscope or equivalent)
- A P3410 pod or a P3420 pod and the necessary cables
- Two SMB to pin header cables (if the P3410 pod is used)
- Two SMB to BNC adapters (if the P3410 pod is used)
- Two SMB to BNC cables (if the P3420 pod is used)

Before Starting Examples

Be sure that the DG2020A is properly installed. Refer to *Installation* on page 1-7.

Turn the DG2020A on. Refer to *Power On* on page 1-12 for details on turning the DG2020A on.

You do not need to connect the oscilloscope until Example 3.

Operating Procedure Sequences

Each operating procedure is presented in table format in order starting with step 1, and progresses through the end of the procedure. Tables such as the one shown below list the steps for each procedure task. For these steps, press the buttons in the order shown in the table, from left to right in each row, from top to bottom of the table. If a number is shown in the front panel button column, enter that value using the keypad. For popup menus, use the general purpose knob to select items from the menu list. Operations such as operation 6 (below) do not involve pressing the buttons shown in the row above, but rather are descriptions of operations to be performed. Figure 2-23 shows the buttons used and the menu layout.

Menu button	Bottom button	Popup menu	Side button	Front panel button
Operation 1	Operation 2	Operation 3	Operation 4	Operation 5
Operation 6 (For example, set to xx with general purpose knob.)				
			Operation 7	

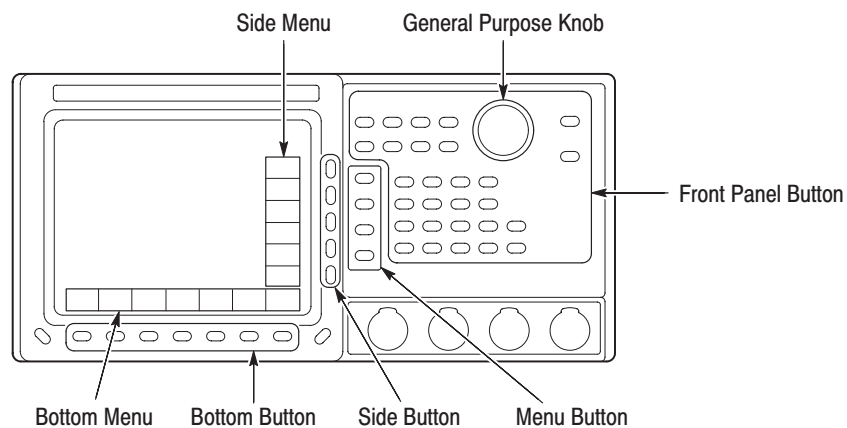

Figure 2-23: Operating buttons and menu layout

Equipment Connections

Connect the DG2020A data generator to either a P3410 or a P3420 pod using a pod connection cable as shown in Figure 2-24.

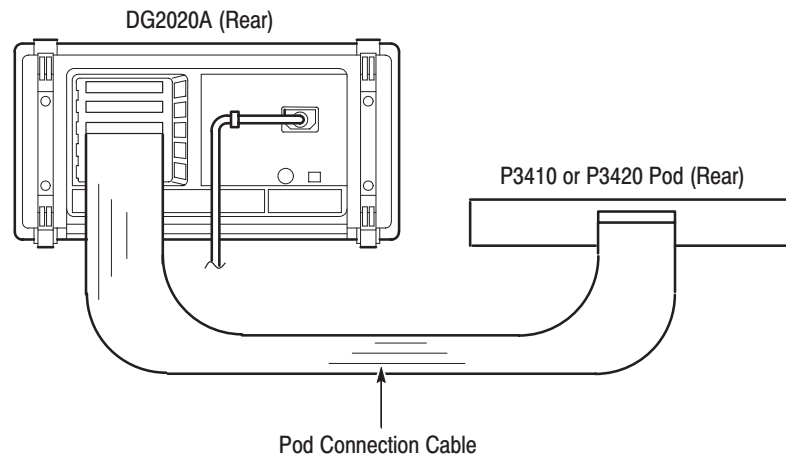

Figure 2-24: Pod connection

Note that the connectors on the DG2020A rear panel are installed with the tab slot down, and the connector on the pod rear panel is installed with the tab slot up (see Figure 2-25).

To connect a cable between the DG2020A and a pod, align the yellow wire end of the cable connector with the triangular yellow index mark on the DG2020A or pod connector. Doing this also correctly aligns the connector alignment tab. See Figure 1-2. Then carefully but firmly insert the cable connector into the DG2020A or pod connector.

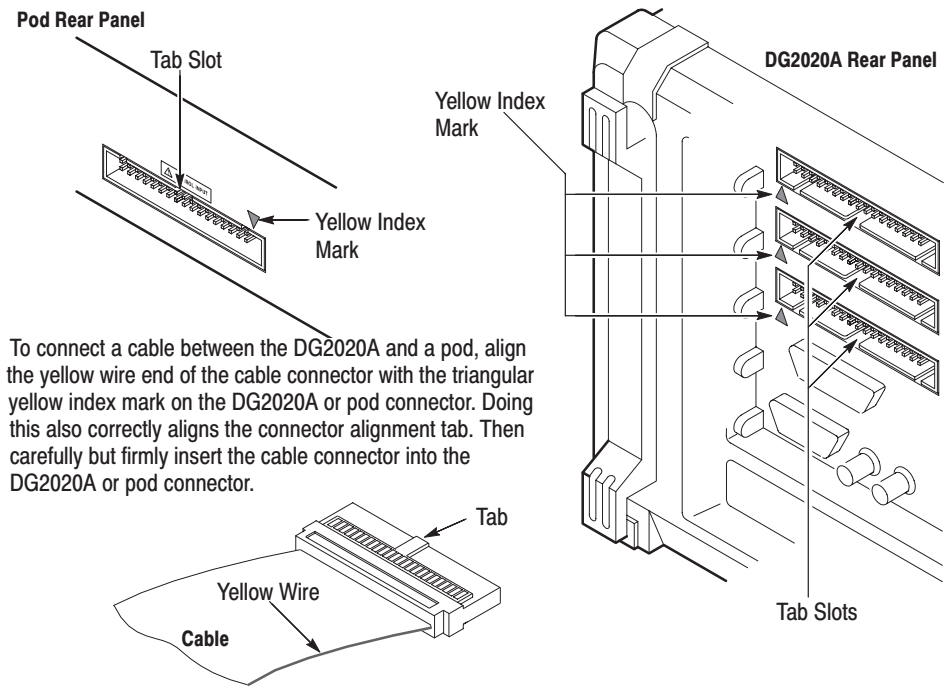

Figure 2-25: Yellow index mark and yellow line for cable connection



CAUTION. Turn off the instrument before connecting it to the pod. Connecting the instrument to the pod with the power on could damage the instrument itself and the pod. When attaching the pod cable, ensure that the plug and socket are aligned correctly.

Make sure that you have correctly inserted the cable plug in the DG2020A and the pod before turning on power. The yellow wire end of the connector must be aligned with the triangular yellow index mark on the DG2020A or pod. Incorrectly connected cables will damage the DG2020A and the pod.

After connecting the equipment correctly, turn on the DG2020A. See *Power On* on page 1-12 for details on turning on the DG2020A.

Connection procedures for the oscilloscope are not required until Example 3.

Example 1: Creating a Pattern and Storing it in a File

Example 1 creates the output pattern for an 8-bit binary counter and stores that pattern on a floppy disk.

Preparation for pattern creation

Before creating new pattern data, initialize the instrument's data and settings.

1. Clear the data group definitions.

Menu button	Bottom button	Popup menu	Side button	Front panel button
SETUP	Group Assign		Reset All bits Assign	
			OK	

2. Clear all data.

Menu button	Bottom button	Popup menu	Side button	Front panel button
EDIT	File		New	
			OK	

Environment Setup for Pattern Creation

3. Set the pattern memory length to 1024 points.

Menu button	Bottom button	Popup menu	Side button	Front panel button
	Settings	Set memory size	OK	1, 0, 2, 4, ENTER
			OK	

- Set the data bit positions and bit widths. Here we will set the height (scope) and width of the data we are going to edit.

Menu button	Bottom button	Popup menu	Side button	Front panel button
	Execute Action	Set scope	OK	
		8	OK	
Move the knob icon to the Cursor window in the upper left of the screen using the front panel CURSOR button.				
				0, ENTER
Move the knob icon to the Width window in the upper left of the screen using the front panel CURSOR button.				
				1, 0, 2, 4, ENTER
Press the down arrow button until the area cursor covers DATA00 to DATA07.				

Pattern creation

- Create the binary pattern for a value being incremented every 4 clock ticks.

Menu button	Bottom button	Popup menu	Side button	Front panel button
	Execute Action	Binary up counter	OK	4, ENTER
			OK	EXECUTE

This creates the binary pattern shown in Figure 2-26 in DATA00 to DATA07.

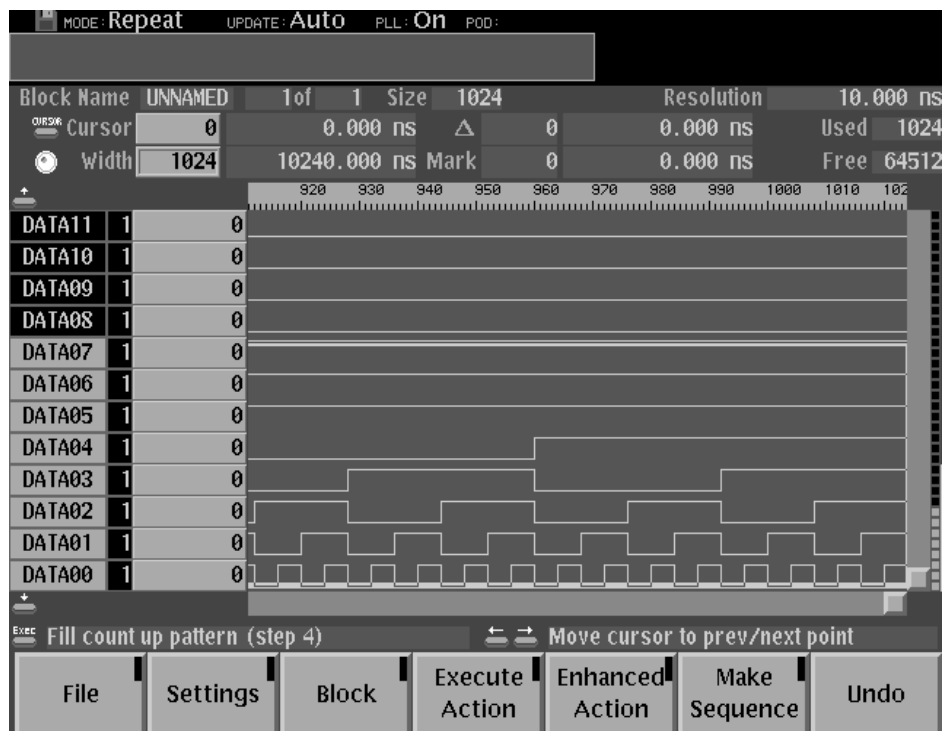

Figure 2-26: Binary pattern creation

Saving the Created Data

6. Save the created data on the floppy disk.
 - a. Insert a writable floppy disk in the drive.
 - b. Name the new file COUNT1.

Menu button	Bottom button	Popup menu	Side button	Front panel button
	File		Save Data & Setup	
			Clear String	
		C,O,U,N,T,1 *	OK	

*: Select each character in the file name using the general-purpose knob and the up and down arrow buttons. Press the **EXECUTE** button to insert the character in the file name.

The data in this procedure will be saved in the file COUNT1.PDA.

Example 2: Loading and Editing a Pattern Stored in a File

Example 2 loads a file from a floppy disk, and demonstrates pattern editing using that data.

Before loading a file from the floppy disk, initialize the instrument's data and settings. This allows you to see the effect of loading the file you previously saved in example 1.

1. Clear the data group definitions.

Menu button	Bottom button	Popup menu	Side button	Front panel button
SETUP	Group Assign		Reset All bits Assign	
			OK	

2. Clear all data.

Menu button	Bottom button	Popup menu	Side button	Front panel button
EDIT	File		New	
			OK	

Reading the File

3. Read in the file created in example 1 from the floppy disk.
 - a. Insert the floppy disk in the instrument's floppy disk drive.
 - b. Execute the following actions.

Menu button	Bottom button	Popup menu	Side button	Front panel button
EDIT	File		Load Data & Setup	
Select the file COUNT1.PDA from the file list using the general-purpose knob.				
			OK	

This loads the pattern created in example 1.

Selecting Bits to Edit

4. Select DATA04 to DATA07 as the area to be edited.

Menu button	Bottom button	Popup menu	Side button	Front panel button
	Execute Action	set scope	OK	
		4	OK	

Move the knob icon to the Cursor window in the upper left of the screen using the front panel CURSOR button.

				0, ENTER
--	--	--	--	----------

Move the knob icon to the Width window in the upper left of the screen using the front panel CURSOR button.

				1, 0, 2, 4, ENTER
--	--	--	--	-------------------

Press the up and down arrow buttons until the area cursor covers DATA04 to DATA07.

Shifting the Pattern

5. Select shift as the edit operation and execute it. This will shift the bits in DATA04 to DATA07 exactly one sample width to the right.

Menu button	Bottom button	Popup menu	Side button	Front panel button
	Execute Action	Shift right (add zero)	OK	EXECUTE

Inserting a Glitch

6. Select invert as the edit operation and execute it. This will insert a glitch with a width of 1 sample in the DATA07 bits.
 - a. Set DATA07 as the bits that will be the object of the edit.

Menu button	Bottom button	Popup menu	Side button	Front panel button
	Execute Action	Set scope	OK	
		1	OK	

Set the block cursor to cover DATA07 using the up and down arrow buttons.

b. Set the glitch width to be 1.

Menu button	Bottom button	Popup menu	Side button	Front panel button
Move the knob icon to the Width window in the upper left of the screen using the front panel CURSOR button.				
				1, ENTER

c. Select invert as the edit operation.

Menu button	Bottom button	Popup menu	Side button	Front panel button
	Execute Action	Invert data	OK	

d. Insert two glitches.

Menu button	Bottom button	Popup menu	Side button	Front panel button
Move the knob icon to the Cursor window in the upper left of the screen using the front panel CURSOR button.				
				3, 2, ENTER
				EXECUTE
				9, 6, ENTER
				EXECUTE

This step inserted glitches at the points for cursor positions 32 and 96.

Figure 2-27 shows the pattern edited in example 2.

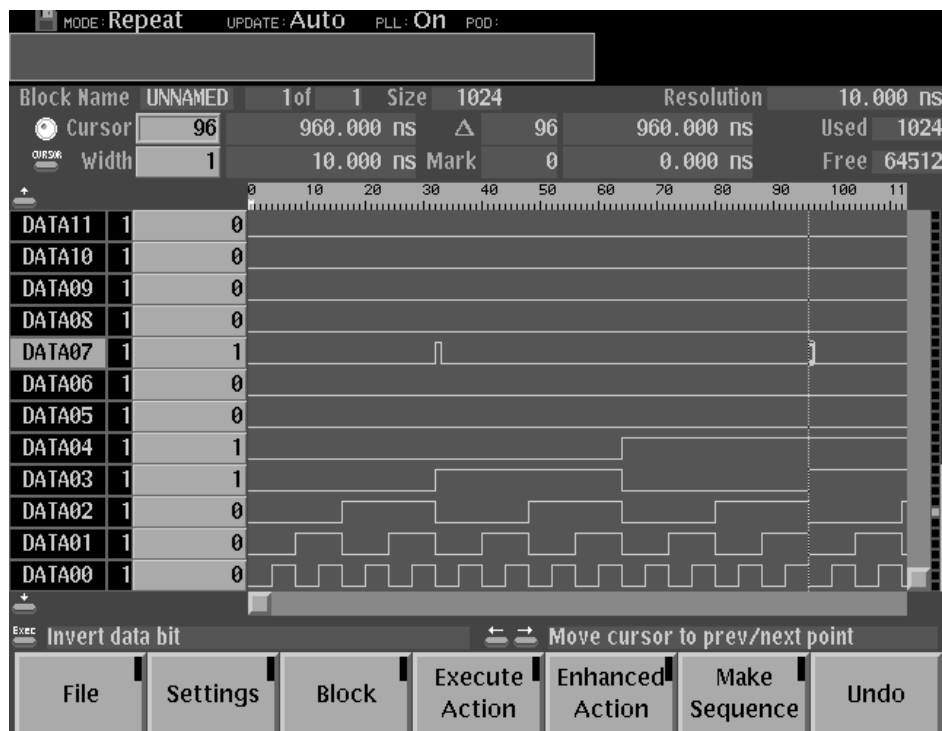

Figure 2-27: Pattern edited in example 2

Saving the Edited Data

7. Save the edited data on the floppy disk.
 - a. Insert a writable floppy disk in the drive.
 - b. Name the new file COUNT2.

Menu button	Bottom button	Popup menu	Side button	Front panel button
	File		Save Data & Setup	
			Clear String	
		C,O,U,N,T,2	OK	

The data in this procedure will be saved in the file COUNT2.PDA.

Example 3: Signal Output

Example 3 first groups the data bits from the pattern data created in example 2 and allocates each data bit to pod pins. Next, this procedure sets all the settings required for signal output and actually outputs the signals.

Grouping the data bits

1. Assign DATA00 to DATA03 to a group called IC1.
 - a. Reset all bit allocations.

Menu button	Bottom button	Popup menu	Side button	Front panel button
SETUP	Group Assign		Reset All bits Assign	
			OK	

- b. Set the MSB (most significant bit) and LSB (least significant bit) to D03 and D00, respectively.

Menu button	Bottom button	Popup menu	Side button	Front panel button
		Select 32 DATA03.	Group Bit(s) Config	
			MSB (Set D03.)	
			LSB (Set D00.)	
			OK	

NOTE. The MSB setting may change depending on the direction the general purpose knob is turned. If that happens, the MSB setting must be set again.

- c. Attach the name IC1 to the newly created group.

Menu button	Bottom button	Popup menu	Side button	Front panel button
			Rename	
			Clear String	
		I, C, 1	OK	

2. Assign DATA04 to DATA07 to a group called IC2.

- a. Set the MSB and LSB.

Menu button	Bottom button	Popup menu	Side button	Front panel button
		Select 28 DATA07.	Group Bit(s) Config	
			MSB (Set D07.)	
			LSB (Set D04.)	
			OK	

NOTE. The MSB setting may change depending on the direction the general purpose knob is turned. If that happens, the MSB setting must be set again.

- b. Attach the name IC2 to the group.

Menu button	Bottom button	Popup menu	Side button	Front panel button
			Rename	
			Clear String	
		I, C, 2	OK	

Allocating Data Bits to the Pod Channels

3. Allocate data bits to pod channels **A-00** to **A-11**.

a. Clear the pod channel for channels **A-00** to **A-03**.

Menu button	Bottom button	Popup menu	Side button	Front panel button
	Pod Assign			

Press the front panel up arrow button to select channel A-00 from the POD assignment list.

			Release	
--	--	--	---------	--

Clear the A-01 to A-03 allocations in the same manner.

b. Allocate the IC1 group data to the pod channels **A-04** to **A-07** and turn off the output impedance control for each channel.

Menu button	Bottom button	Popup menu	Side button	Front panel button
-------------	---------------	------------	-------------	--------------------

Press the front panel down arrow button to select channel A-04 from the POD assignment list.

Select data D03 (IC1:03) from the Data bits list using the general purpose knob.

			Assign	
			Change Inhibit Control	
		Select OFF.	OK	

Allocate D02 to D00 to A-05 to A-07 using the same procedure and turn off the output impedance control for each channel.

			OK	
--	--	--	----	--

NOTE. Press the **OK** button when done to activate the allocations. Note that the allocations will not become valid unless the **OK** button is pressed.

c. Allocate the **IC2** group data to the pod channels **A-08** to **A-11** and turn off the output impedance control for each channel.

Menu button	Bottom button	Popup menu	Side button	Front panel button
	Pod Assign			
Press the front panel down arrow button to select channel A-08 from the POD assignment list.				
Select data D07 (IC2:03) from the Data bits list using the general purpose knob.				
			Assign	
			Change Inhibit Control	
		Select OFF.	OK	
Allocate D06 to D04 to A-09 to A-11 using the same procedure and turn off the output impedance control for each channel.				
			OK	

NOTE. Press the **OK** button when done to activate the allocations. Note that the allocations will not become valid unless the **OK** button is pressed.

To summarize data bits have been allocated what we have done above, to the pods as shown in Figure 2-28.

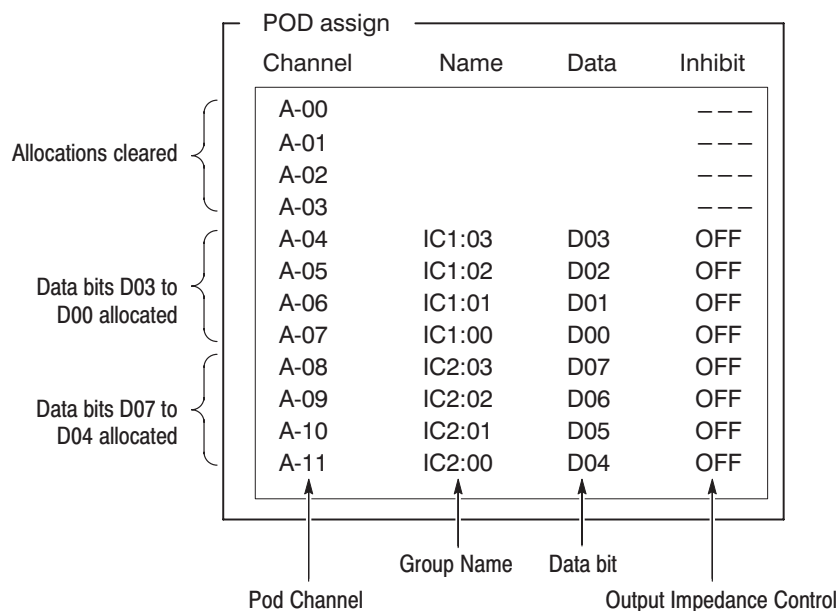

Figure 2-28: Pod channel data bit allocation

Setting the Sampling Clock Frequency

- Set the sampling clock frequency to 50 MHz.

Menu button	Bottom button	Popup menu	Side button	Front panel button
	Oscillator		Source (Select Int.)	
			Int Frequency	5, 0, MHz
			PLL (Select On.)	

Setting the Signal Generation Mode

- Set the signal generation mode to continuous mode.

Menu button	Bottom button	Popup menu	Side button	Front panel button
	Run Mode		Repeat	

Setting the Pod Output Level (P3420 Only)

There are two pod models that can be used with the DG2020A. The P3410 pod output level is always at the TTL level. The P3420 pod output level is variable. This step sets output levels for the P3420 pod.

- Set the pod channel A-04 to A-011 output levels to 4V for the high level and 0V for the low level.

The output level of the channels from A-00 to A-07 cannot be set independently (meaning that you can set same output level over these channels), while the output level from A-08 to A-11 can be set independently in each channel.

Menu button	Bottom button	Popup menu	Side button	Front panel button
	Level/Delay			
Select channel A-04 using the front panel up and down arrow buttons.				
			High Level	4, ENTER
			Low Level	0, ENTER
Set the output levels for channels A-08 to A-11 in the same manner.				

Setting the Pod Delay Time

The delay time for channels **A-08** to **A-11** is variable in both the P3410 and the P3420 pod.

- Set the delays for the pod channels **A-08** to **A-11** to 5 ns.

Menu button	Bottom button	Popup menu	Side button	Front panel button
	Level/Delay			
Select channel A-08 using the front panel up and down arrow buttons.				
			Delay	5, ENTER
Set the delays for channels A-09 to A-11 in the same manner.				

Delay Time Setting

Output Voltage Level Setting

Channel	Data [Group:Bit]	High	Low	Delay	Inhibit
A-00	---	4.0 V	0.0 V	-----	OFF
A-01	---	4.0 V	0.0 V	-----	OFF
A-02	---	4.0 V	0.0 V	-----	OFF
A-03	---	4.0 V	0.0 V	-----	OFF
A-04	D03 [IC1:03]	4.0 V	0.0 V	-----	OFF
A-05	D02 [IC1:02]	4.0 V	0.0 V	-----	OFF
A-06	D01 [IC1:01]	4.0 V	0.0 V	-----	OFF
A-07	D00 [IC1:00]	4.0 V	0.0 V	-----	OFF
A-08	D07 [IC2:03]	4.0 V	0.0 V	5.0 ns	OFF
A-09	D06 [IC2:02]	4.0 V	0.0 V	5.0 ns	OFF
A-10	D05 [IC2:01]	4.0 V	0.0 V	5.0 ns	OFF
A-11	D04 [IC2:00]	4.0 V	0.0 V	5.0 ns	OFF

Figure 2-29: Output voltage level and delay time display for the P3420 pod

Signal Output This step actually outputs the signals and confirms those signals with an oscilloscope.

8. Connect the pod to the oscilloscope.

P3410 Pod

Connect the pins **CH7** and **CH8** on the P3410 pod to the oscilloscope channels CH1 and CH2. This requires two SMB to pin header cables and two SMB to BNC adapters as shown in Figure 2-30.

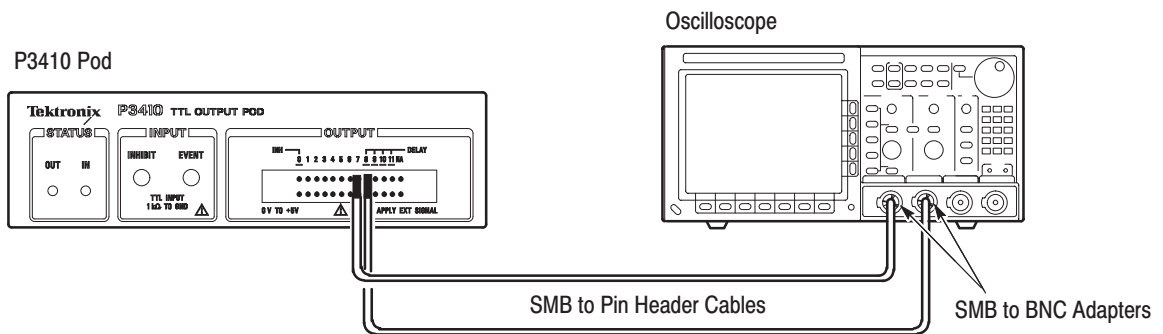

Figure 2-30: P3410 pod/oscilloscope connection

P3420 Pod

Connect the **CH7** and **CH8** outputs from the P3420 pod to the oscilloscope channels CH1 and CH2. This requires two SMB to BNC cables as shown in Figure 2-31.

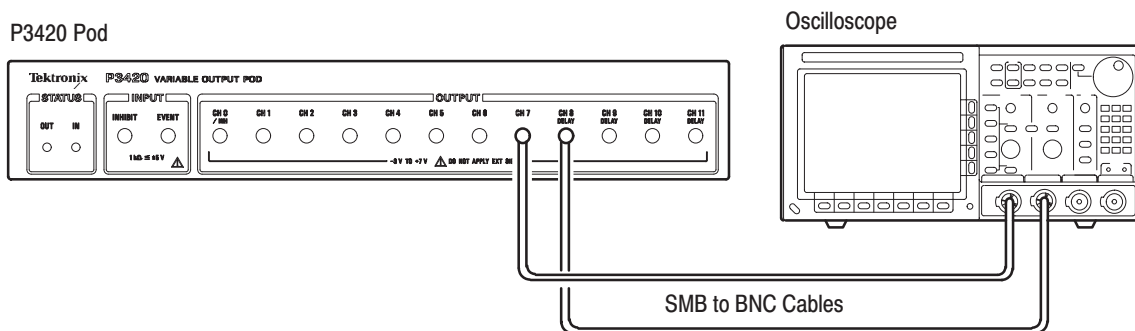

Figure 2-31: P3420 pod/oscilloscope connection

9. Press the **START/STOP** button on the front panel.
10. Set up the oscilloscope appropriately and observe the pattern signals on the oscilloscope screen.

If a P3420 pod is used, change the delay time and output level settings (see steps 6 and 7) and observe the results.

If a P3410 pod is used, change the delay time setting (see step 7) and observe the results.

Saving the State of the Settings

11. Save the state of the settings on the floppy disk.
 - a. Insert a writable floppy disk in the drive.
 - b. Name the new file COUNT3.

Menu button	Bottom button	Popup menu	Side button	Front panel button
EDIT	File		Save Data & Setup	
			Clear String	
		C, O, U, N, T, 3	OK	

The data in this procedure will be saved in the file COUNT3.PDA.

Example 4: Creating a Sequence

Example 4 prepares four 128-bit blocks and creates the following sequence by combining those blocks.

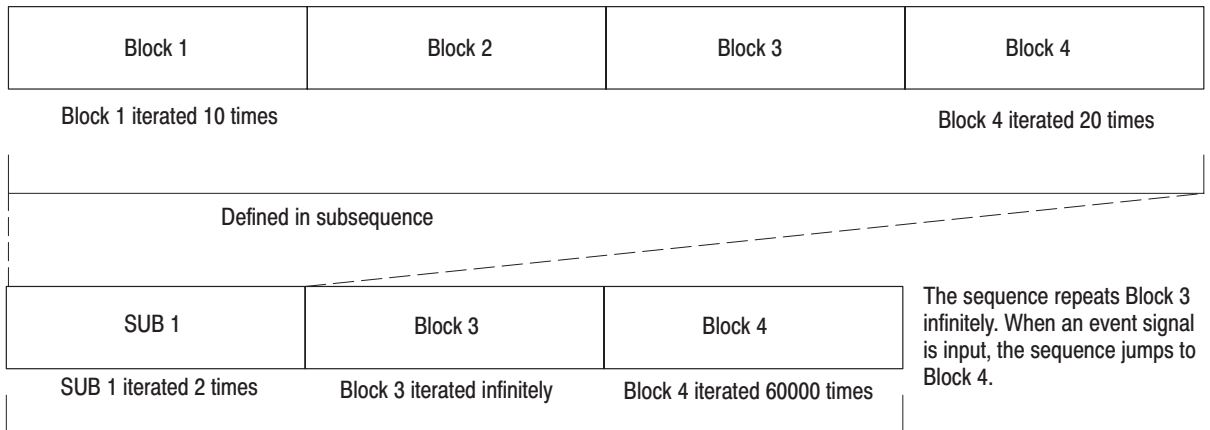

First, create the following data patterns for the blocks.

- Block 1: Binary up-counter pattern
- Block 2: Data pattern consisting of all zeros
- Block 3: Binary down-counter pattern
- Block 4: Johnson counter pattern

Preparing to Create Data

1. Clear the data group definitions.

Menu button	Bottom button	Popup menu	Side button	Front panel button
SETUP	Group Assign		Reset All bits Assign	
			OK	

2. Clear all data.

Menu button	Bottom button	Popup menu	Side button	Front panel button
EDIT	File		New	
			OK	

3. Set the length of pattern memory (the number of samples) to 512 bits.

Menu button	Bottom button	Popup menu	Side button	Front panel button
	Settings	Set memory size	OK	5, 1, 2, ENTER
			OK	

4. Set the block cursor position and width. This operation uses a scope of 8 (DATA00 to DATA07) and a width of 128 samples.

Menu button	Bottom button	Popup menu	Side button	Front panel button
	Execute Action	set scope	OK	
		8	OK	

Move the knob icon to the Width window in the upper left of the screen using the front panel CURSOR button.

				1, 2, 8, ENTER
--	--	--	--	----------------

Set the block cursor to cover DATA00 to DATA07 using the up and down arrow buttons.

Menu button	Bottom button	Popup menu	Side button	Front panel button
				2, 5, 6, ENTER
	Block	Add block delimiter here	OK	
			Clear String	
		B, K, 3	OK	

7. Divide the data from point 256 to point 383 between block 3 (256 to 383) and block 4 (384 to 511). Use BK4 as the name for block 3. Confirm that the knob icon appears in the **Cursor** window in the upper left of the screen. If the icon is not in that window, move it there with the front panel **CURSOR** button.

Menu button	Bottom button	Popup menu	Side button	Front panel button
				3, 8, 4, ENTER
	Block	Add block delimiter here	OK	
			Clear String	
		B, K, 4	OK	

8. Change the name for block 1 to BK1. Confirm that the knob icon appears in the **Cursor** window in the upper left of the screen. If the icon is not in that window, move it there with the front panel **CURSOR** button.

Menu button	Bottom button	Popup menu	Side button	Front panel button
				0, ENTER
	Block	Rename current block	OK	
			Clear String	
		B, K, 1	OK	

Creating Block 1 Data

9. Create binary up-counter data in block 1. First make sure that the value of the Cursor window in the upper left of the screen is 0. Set that value to 0 if it is not already 0. Perform the following operation.

Menu button	Bottom button	Popup menu	Side button	Front panel button
	Execute Action	Binary up counter	OK	1, ENTER
			OK	EXECUTE

Block 2 Data

The block 2 data is already all zeros. The data can be used as is without editing.

Creating tBlock 3 Data

10. Create binary down-counter data in block 3. Confirm that the knob icon appears in the **Cursor** window in the upper left of the screen. If the icon is not in that window, move it there with the front panel **CURSOR** button.

Menu button	Bottom button	Popup menu	Side button	Front panel button
				2, 5, 6, ENTER
	Execute Action	Binary down counter	OK	1, ENTER
			OK	EXECUTE

Creating the Block 4 Data

11. Create johnson counter data in block 4. Confirm that the knob icon appears in the **Cursor** window in the upper left of the screen. If the icon is not in that window, move it there with the front panel **CURSOR** button.

Menu button	Bottom button	Popup menu	Side button	Front panel button
				3, 8, 4, ENTER
	Execute Action	Johnson counter	OK	EXECUTE

Create a Sequence In the following example, create one subsequence as shown in Figure 2-33.

LINE NUMBER	No.	BLOCK NAME	REPEAT COUNT	
0	1	BK1	10	25600.000000 ns
1	2	BK2	1	2560.000000 ns
2	3	BK3	1	2560.000000 ns
3	4	BK4	20	51200.000000 ns
total		4 lines		

Figure 2-33: Sample subsequence

The following outputs are made when this subsequence is called from the sequence:

- The pattern in BK1 is output 10 times.
- The BK2 pattern is output once.
- The BK3 pattern is output once
- The BK4 pattern is output 20 times.

Next, create a sequence, as shown in Figure 2-34. Each sequence line defines a block or subsequence that is executed in the order listed. When the sequence is executed, the lines defined with subsequence call those subsequences and execute them.

The BLOCK column of the lines defined with subsequences becomes highlighted (gray) to distinguish from those defined with blocks, as shown in Figure 2-34.

Make Sequence									
LINE NUMBER	No.	BLOCK NAME	REPEAT COUNT	INF	ENHANCED TRIG ON WAIT	EVENT JUMP TO			
0	1	SUB1	1		ON			81920.000	ns
1	1	SUB1	1		ON			81920.000	ns
2	1	BK1		∞	ON	3	∞		
3	4	BK4	60000					153600000.000	ns
total		4 lines							

Figure 2-34: Sample sequence

The sequence is performed as follows:

- **Line 0:** Wait trigger event and then call subsequence.
- **Line 1:** Wait trigger event and then call subsequence.
- **Line 2:** Wait trigger event and then the BK1 pattern is repeatedly output while waiting event signal. When the event condition has been satisfied, the process jumps to the line 3.
- **Line 3:** The BK4 pattern is output 60000 times.

The following two steps create the subsequence.

12. Bring up the Make sub-sequence popup menu for preparation.

Menu button	Bottom button	Popup menu	Side button	Front panel button
	Make Sequence		Special	
			Edit Sub-Sequence	
			New	

13. Create the lines in the popup menu and assign the name SUB1 to the subsequence.

Menu button	Bottom button	Popup menu	Side button	Front panel button
			Insert	
Select the BK1 from the Select block popup menu using the front panel knob.				
			OK	
			Repeat	1, 0, ENTER
With the front panel down arrow button, advance the line pointer to the next line. See Figure 2-35.				
Using the same procedures as above, insert BK2, BK3 and BK4 into the line 1, 2 and 3, respectively, and set the repeat count to 20 for the BK4.				
			OK	
			Clear String	
		S, U, B, 1	OK	
			Go Back	
			Go Back	

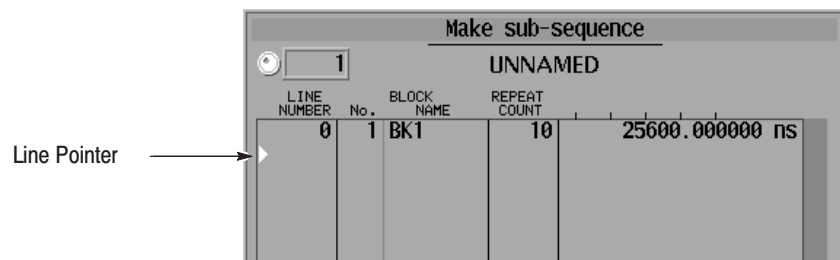

Figure 2-35: Line pointer

The following three steps create the sequence.

14. Create the first two lines in the sequence list.

Menu button	Bottom button	Popup menu	Side button	Front panel button
			Insert	
Select the SUB1 from the Select block and subsequence popup menu using the front panel knob.				
			OK	
			Set Enhanced Control	
			Trig Wait (Set to On)	
			Go Back	
With the front panel down arrow button, advance the line pointer to the next line.				
Using above procedures, insert SUB1 into the line 1 and set the Trig Wait.				

15. Create the next two lines in the sequence list. Note that you cannot set a jump address (sequence line number) that has not yet been created. The jump condition is set in step 16.

Menu button	Bottom button	Popup menu	Side button	Front panel button
			Insert	
Select the BK1 from the Select block and subsequence popup menu using the front panel knob.				
			OK	
			Set Enhanced Control	
			Repeat (Set to Infinite)	
			Go Back	
With the front panel down arrow button, advance the line pointer to the next line.				
Using above procedures, insert BK4 into the line 3.				
			Repeat Count	6, 0, 0, 0, 0, ENTER

16. Finish editing line 3 and then terminate sequence editing.

Menu button	Bottom button	Popup menu	Side button	Front panel button
With the front panel up arrow button, move the line pointer back to the line 2.				
			Set Enhanced Control	
			Event Jump (Set to On)	
			Jump to	3, ENTER
			Go Back	

The following two steps set the trigger and run mode for output.

17. Set the run mode to Enhanced.

Menu button	Bottom button	Popup menu	Side button	Front panel button
SETUP	Run Mode		Enhanced	

Note that, when the run mode is set to Enhanced, the displayed settings in the **ENHANCED** columns of the Make Sequence menu become gray. See Figure 2-36.

LINE NUMBER	No.	BLOCK NAME	REPEAT COUNT	INF	ENHANCED TRIG ON	ENHANCED WAIT	ENHANCED JUMP TO		
0	1	SUB1	1		ON	---		81920.000 ns	
1	1	SUB1	1		ON	---		81920.000 ns	
2	1	BK1		∞	ON	---	3	∞	
3	4	BK4	60000		---	---		153600000.000 ns	
total		4 lines							

Figure 2-36: Sample sequence

Assigning the pod

18. Assign the data bits to output channels. In this example, DATA00 is assigned to A-07. See Figure 2-37.

Menu button	Bottom button	Popup menu	Side button	Front panel button
SETUP	Pod Assign			
Select channel A-07 from the POD assign list using the front panel down arrow button.				
Select data DATA00 from the Data bits list using the general purpose knob.				
			Assign	
			OK	

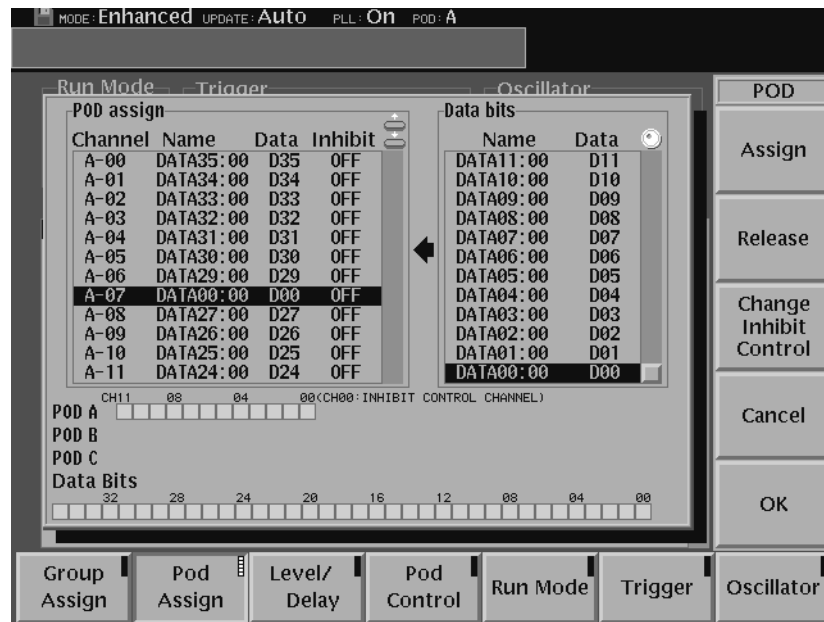

Figure 2-37: Pod assignment

19. Try to output the sequence and observe the pattern using an oscilloscope.

For the connection between the DG2020A and an oscilloscope, see Figure 2-30 on page 2-52.

Press the **START/STOP** button on the front panel to start output.

The first three lines in the sequence wait a trigger event. Press the **FORCE TRIGGER** button on the front panel to generate the trigger event.

Sequence line 2 outputs the BK1 pattern repeatedly until the event condition is satisfied. Press the **STEP/EVENT** button on the front panel to quit the loop and to advance to the line 3.

In Enhanced mode, sequence is repeatedly output until the **START/STOP** button on the front panel is pressed.

Saving the Example Sequence

20. Exit sequence creation mode and save the data in a file. Name the file SEQ1.

Menu button	Bottom button	Popup menu	Side button	Front panel button
Insert a writable floppy disk into the floppy disk drive.				
	File		Save Data & Setup	
			Clear String	
		S, E, Q, 1	OK	

This creates the file called SEQ1.PDA. If a file of the same name already exists a message asking if that file should be overwritten will be displayed. Press **OK** once more if that message is displayed.

Reference

This section describes the following menus in detail.

- **Edit Menu**

Provides functions for editing pattern data and creating sequences.

- **Setup Menu**

Provides functions for defining groups, setting up channels, and setting pod voltages, the operating mode, and triggers.

- **Application Menu**

Although the current version of the firmware does not provide any functions under the **APPLICATION** menu, Tektronix plans to provide functions that support various application areas under this menu in future upgrades to the firmware.

- **Utility Menu**

This menu provides functions for manipulating the basic instrument settings.

Operation Outlines

Figure 3-1 and Figure 3-1 show a typical example for operation flow from creating and editing pattern data to outputting it.

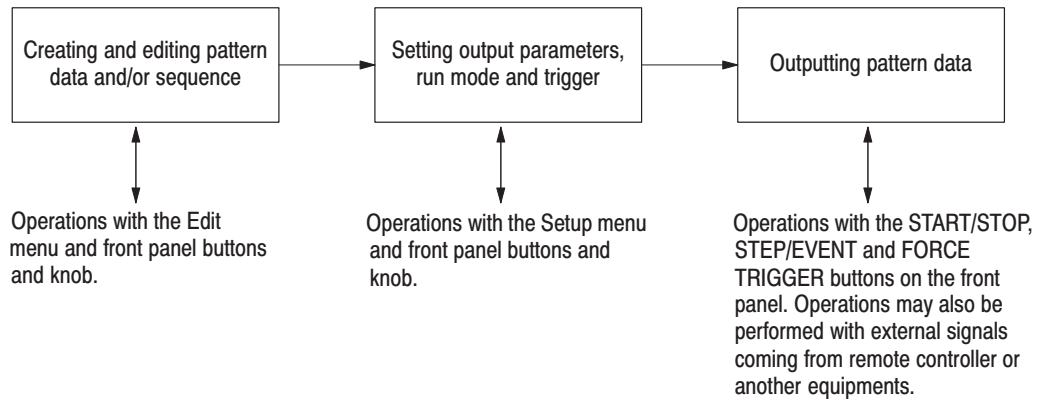

Figure 3-1: Operation flow for pattern data output #1

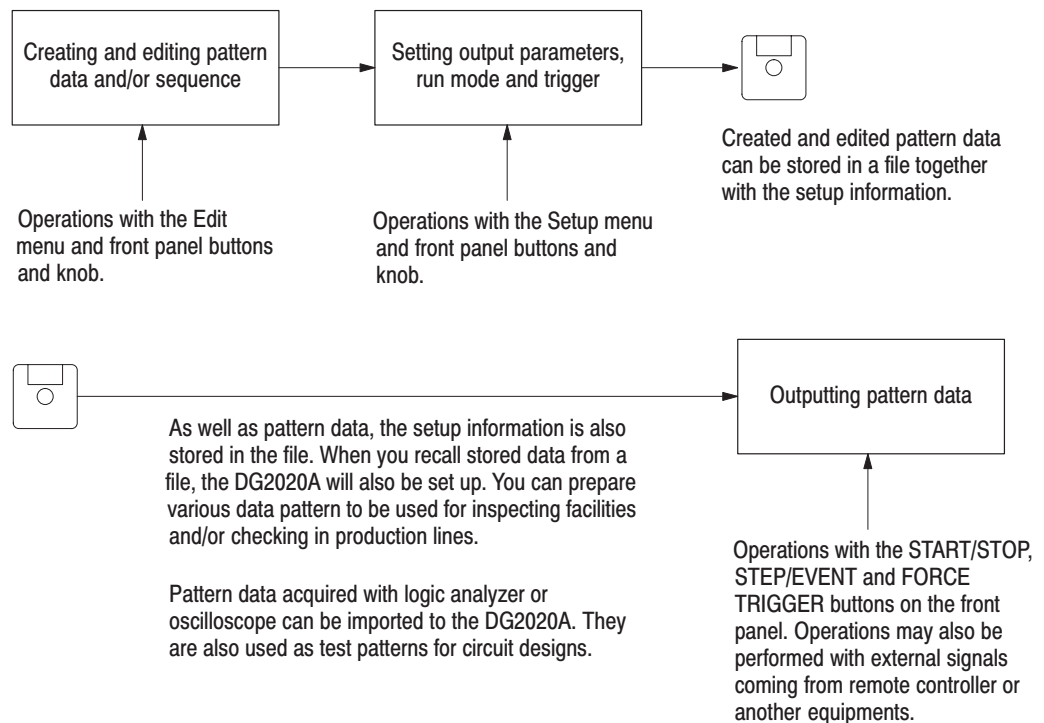

Figure 3-2: Operation flow for pattern data output #2

Outlines for Pattern Data and Sequence Creations

You create and edit data pattern by using EDIT menu.

Pattern Data Here is a basic operation flow for creating a pattern data.

1. Set memory size with **EDIT** → **Settings** → **Set memory size**. In default, the memory size is 1000 word.
2. Specify the work area with **EDIT** → **Execute Action** → **Set Scope** and **Width** on the screen.
3. Create pattern data with the functions in **EDIT** → **Execute Action**.
4. Repeat step 2 and 3 until the pattern data that you want is created.

Sequence Here is a basic operation flow for creating a sequence.

1. Create more than one block (pattern data delimited by block delimiter) on the pattern memory as following steps:
 - a. Create first block pattern using the procedures described in *Pattern Data* above.
 - b. Change the block name with **EDIT** → **Block** → **Rename current block**.
 - c. Move the cursor to the next point to the end of the pattern data by changing the value in the **Cursor** on the screen.
 - d. Mark the block delimiter with **EDIT** → **Block** → **Add block delimiter here**. This causes to start new block. The block must has an unique name, and you can enter it at this time or with the way of step b.
 - e. Create next block pattern using the procedures described in *Pattern Data* above.
 - f. Repeat step c to e until all blocks you need are created.
2. Create sequence table as following steps:
 - a. Open the sequence editor with **EDIT** → **Make Sequence**.
 - b. If you need, create sub-sequence(s) with **EDIT** → **Make Sequence** → **Special** → **Edit Sub-Sequence** → **New**.
 - c. Compose the lines by inserting the blocks and/or sub-sequences with **EDIT** → **Make Sequence** → **Insert**.

- d. Define the control conditions in each line with **EDIT → Make Sequence → Repeat Count** and/or the functions of **EDIT → Make Sequence → Set Enhanced Control**.

Setups for Output

Once you have created a pattern data or sequence, configure the hardware of the DG2020A and set the output parameters.

1. Assign data bits to output channels with **SETUP → Pod Assign → Assign**.
2. Set the pulse high and low levels with **SETUP → Level/Delay**.
3. Set the output frequency with the functions of **SETUP → Oscillator**.

Outputs

Do the following steps to output pattern data.

1. Press the **START/STOP** button on the front panel to start outputting.
2. Press the **START/STOP** button again to stop outputting.

Advanced Control for Sequence

Using the event, trigger and run mode, you can control the pattern data output timing and sequence as your request from the external controller or just pressing the front panel buttons. For advanced control:

1. Set the trigger wait and/or event jump into each line on the sequence with the functions of **EDIT → Make Sequence → Set Enhanced Control**. See *Sequence* described above.
2. Set the trigger parameters with **SETUP → Trigger**.
3. Set the event and/or inhibit parameters with **SETUP → Pod Control**.
4. Set the run mode with **SETUP → Run Mode**.

Edit Menu

The bottom menu for the **EDIT** menu includes the **File**, **Settings**, **Block**, **Execute Action**, **Enhanced Action**, **Make Sequence**, and **Undo** items. Table 3-1 lists the functions of the **EDIT** menu items and the pages where their documentation appears.

Table 3-1: Menu functions

Bottom menu	Side menu or popup menu	Function	Page
File	Load Data & Setup	Loading pattern data and setup parameters	3-9
	Save Data & Setup	Saving pattern data and setup parameters	3-9
	Import Data	Loading pattern data from mass memory	3-10
	Export Data	Writing pattern data to mass memory	3-15
	New	Initialization for data creation	3-17
Settings	Place mark here	Setting the reference mark	3-18
	Select reference group	Setting the reference group	3-18
	Unselect reference group	Clearing the reference group setting	3-19
	Set memory size	Setting the memory size	3-19
	Select arrow key function	Setting the operation of the arrow buttons	3-20
	Set view type to timing	Setting the pattern data display format	3-22
	Set view type to table		
Set view type to binary			
Block	Move to block start	Moving the cursor for the block	3-24
	Move to block end		
	Move to next block		
	Move to previous block		
	Move to block(any)		
	Add block delimiter here	Delimiting blocks	3-25
	Delete current block delimiter	Combining blocks	3-26
	Rename current block	Changing a block name	3-27
	Resize current block	Changing the size of a block	3-27
Execute Action	Set scope	Setting the scope	3-30
	Cut	Deleting pattern data	3-31
	Copy	Copying pattern data	3-31
	Paste - insert	Pasting (inserting) pattern data	3-31

Table 3-1: Menu functions (Cont.)

Bottom menu	Side menu or popup menu	Function	Page
Execute Action	Paste - replace	Pasting (replacing) pattern data	3-32
	Set data to high	Setting pattern data to high	3-32
	Set data to low	Setting pattern data to low	3-32
	Insert high data	Inserting high data	3-33
	Insert low data	Inserting low data	3-33
	Invert data	Inverting pattern data	3-33
	Mirror vertical	Swapping pattern data in the vertical direction	3-34
	Mirror horizontal	Swapping pattern data in the horizontal direction	3-35
	Magnify	Magnifying pattern data	3-35
	Numeric input	Inputting pattern data numerically	3-35
	Shift left (add zero) or Shift right (add zero)	Shifting pattern data left or right by inserting zeros	3-37
	Shift left or Shift right	Shifting pattern data left or right	3-37
	Shift up (add zero) or Shift down (add zero)	Shifting pattern data up or down	3-38
	Shift up or Shift down	Shifting pattern data up or down	3-38
	Rotate left or Rotate right	Rotating pattern data left or right	3-39
	Rotate up or Rotate down	Rotating pattern data up or down	3-39
	Binary up counter	Creating standard pattern data	3-40
	Binary down counter		
Johnson counter			
Graycode counter			
Enhanced Action	Clock Pattern	Clock pattern generation	3-42
	Shift Register Generator	Pseudorandom pulse generation	3-44
	Logical Operation	Logical operations between pattern data items	3-47
	Bit Operation	Moving or copying pattern data	3-49
	Serial Code Converter	Serial code data conversion	3-50
Make Sequence	Insert	Sequence definition (subsequence included)	3-55
	Delete		3-56
	Repeat Count		3-56
	Set Enhanced Control		3-56
	Special		3-57

CRT Display

This section describes the **EDIT** menu screen shown in Figure 3-3. Table 3-2 provides a description and page number references.

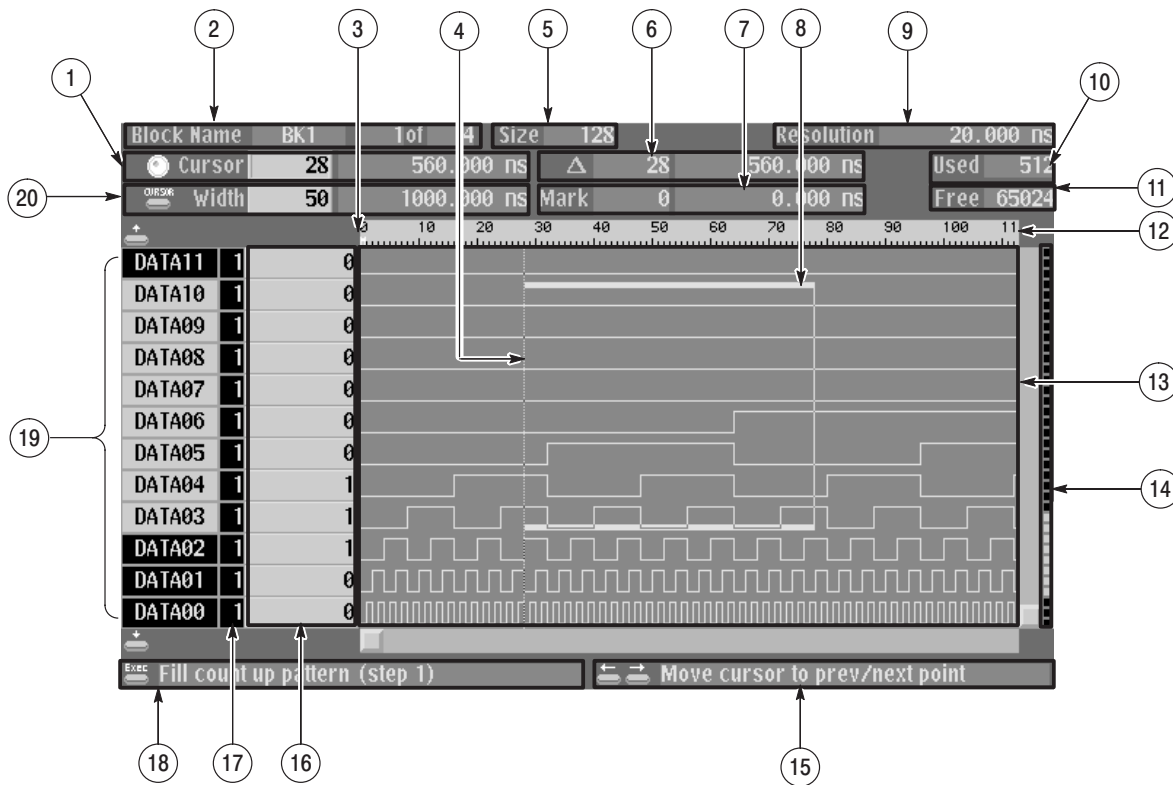

Figure 3-3: EDIT menu (timing display)

Table 3-2: Edit menu crt display

Screen reference	Function	Page
1	Displays the point position of the cursor pointer, and the time from the start of the data. When the knob icon is displayed at the left edge, the cursor can be moved with the general purpose knob.	
2	The block name. Also the adjacent area is used to display the position of the current block with respect to the total number of blocks. There are four blocks in the example shown in the figure, and currently the first block is being displayed.	
3	Displays an M to mark the position of the reference.	3-18
4	The cursor	
5	Displays the memory size of the block at the cursor position.	3-19
6	Displays the difference between the reference mark (3) and the cursor as a number of points and also as a time.	
7	Displays the position of the reference mark (3) as a point value and as a time.	
8	The area cursor. The area enclosed by this cursor is the object of the execute action editing operations. The area is set by the Set scope (vertical) in the Execute Action menu and Width (horizontal) items.	
9	Displays the time per point.	
10	Displays the total memory size for all blocks.	
11	Displays the size of the remaining available memory.	
12	A scale which shows point positions.	
13	Display area for the pattern data.	
14	Displays the scope and data bits that are displayed on the current screen relative to all the data bits.	
15	Describes the current action of the arrow buttons.	3-20
16	Displays the value of the data at the cursor position (4).	
17	Displays the number of bits in the data bit group.	
18	Describes the function of the front panel EXECUTE button. Pressing the EXECUTE button executes the editing function for the indicated cursor position or area.	3-28
19	Indicates the data bits or the data bit groups. Data bits that are set up to be the object of editing operations are displayed at a higher intensity (bright).	
20	Displays the width of the area cursor as a number of points and as a time.	

File Menu

The File menu saves and loads data between the instrument's internal memory and mass memory (floppy disks). When the **File** bottom menu item is selected, a side menu with **Load Data & Setup**, **Save Data & Setup**, **Import**, **Export**, and **New** items is displayed.

Load Data & Setup

Reads format pattern data, block, group, sequence and setup data into the instrument's internal memory from mass memory (floppy disk).

Sub Menu

Item	Function
Change Directory	Changes the current directory.

Operation. Load the pattern data and setup parameters

Bottom button	Popup menu	Side button
	Insert a floppy disk in the floppy disk drive.	
File		Load Data & Setup
	Select the file to be loaded.	OK

Save Data & Setup

Stores the pattern data, block, group, sequence and setup data from the instrument's internal memory to mass memory (floppy disk) in DG2020A format.

Sub Menu

Item	Function
Clear String	Deletes the current displayed string.
Change Directory	Changes the current directory.

Operation. Save the pattern data and setup parameters

Bottom button	Popup menu	Side button
Insert a write-enabled floppy disk in the floppy disk drive.		
File		Save Data & Setup
	Enter the file name for the data to be saved.	OK

Import Loads pattern data from mass memory (floppy disk) into pattern memory. The following data formats can be read in:

- Tektronix TDS series waveform data (file extension: .WFM)
- Tektronix TLS series group data (file extension: .GRP)
- Tektronix AWG2000 series waveform data (file extension: .WFM)
- CSV format data (file extension: .CSV). A procedure for formatting data in a CSV format is on page 3-13.

Popup menu parameter settings are used to specify the read-in method.

Operation. Read in pattern data from mass memory.

Bottom button	Popup menu	Side button
Insert the floppy disk in the drive.		
File		Import Data
	Select the file to be read in.	OK
	Change the parameters as required.	OK

Popup Menu. Figure 3-4 shows the data read-in configuration window. The parameters that appear in this window differ depending on the data format being read in.

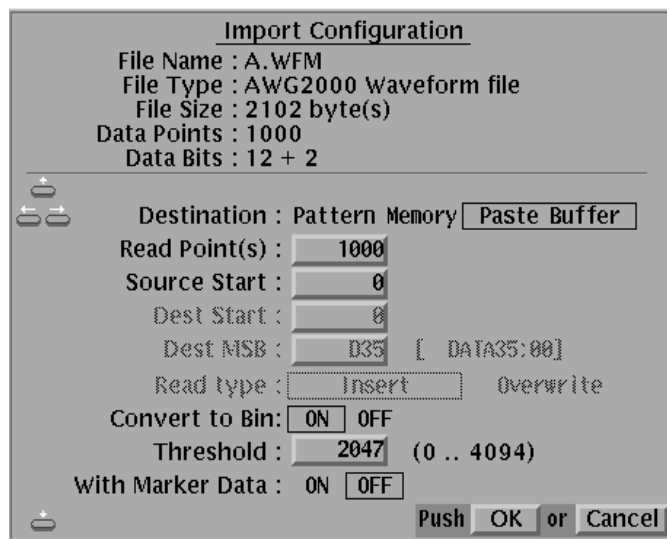

Figure 3-4: Import configuration menu (file format: AWG2000 series waveform file)

Table 3-3 describes the parameters.

Table 3-3: Import parameters

Parameter	Function
Destination	Sets the place where the read-in data is to be written. Either Pattern memory or the Paste buffer can be selected. If data is read into the paste buffer, data can be pasted to the data bit specified by the Paste item in the Execute Action menu.
Read Point(s)	Sets the number of data points to be read. Data in excess of the specified memory size cannot be read in.
Source Start	Specifies the starting position from which the data is read in from the file.
Dest Start	Specifies the position which data is read in when pattern memory is the destination.
Dest MSB	Specifies the position of the MSB to which data will be written when pattern memory is the destination.
Read type	Sets the data read-in method when pattern memory is the destination. Either Insert or Overwrite can be selected.
Convert to Bin	When this setting is set to ON, the waveform is compared to a threshold level and the data is converted to binary. RP binary data from the Tektronix TDS and TLS series products are read in as RI data. The data cannot be converted to binary data if it is left in the RP state.

Table 3-3: Import parameters (Cont.)

Parameter	Function
Threshold	Sets the threshold level used to convert read-in data to binary when the Convert to Bin parameter is set ON.
With Marker Data	Sets whether or not marker data is read, in addition to waveform data, for Tektronix AWG2000 series waveform file format data.

Figures 3-5 and 3-6 show the data write operations in terms of point positions and data bit positions when pattern memory is the write destination.

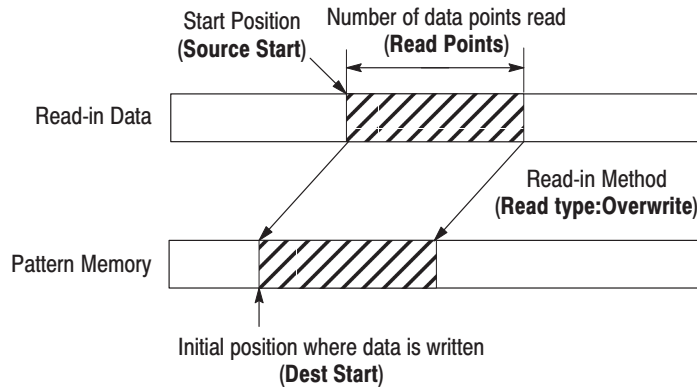

Figure 3-5: Data write in terms of point positions

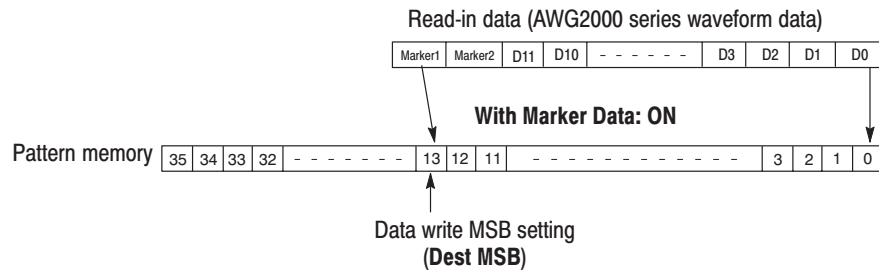

Figure 3-6: Data write in terms of data bit positions

Formatting Data in CSV Format

The DG2020A can import vector data from the built-in floppy drive using a simple ASCII Comma Separated Variable (CSV) format. This section defines how the data is formatted for importing into the DG2020A. The CSV format is defined as follows:

<1DB0><Comma><1DB1><Comma>.....<1DBx><CR>	! The number of bits defines (x) defines the width of the pattern
<2DB0><Comma><2DB1><Comma>.....<2DBx><CR>	! Second word
... ..	
<yDB0><Comma><yDB1><Comma>.....<yDBx><CR>	! The number of lines (y) defines the depth of the pattern

When formatting data in the CSV format, note the following:

- Each data byte is defined by the ASCII character: zero <0>, ASCII 48 or one <1>, ASCII 49
- Each data byte is separated by the ASCII character: comma <,> (ASCII 44), space (ASCII 32), or TAB (ASCII 9)
- Each line is terminated with the ASCII character: carriage return <CR>, ASCII 13
- The number of bits in a line defines the word width. For example, if the first line consists of pattern: 1,0,1,1 then the word width is 4 bits wide
- The number of lines in the file defines the number of words in the pattern. For example, 10 lines defines 10 data words.
- The DG2020A CSV format file is a DOS compatible file formatted as defined above with a .CSV file extension.

CSV Format Example. To export a 12 bit pattern that is 3 words long, create the following data and save it using filename: PATTERN.CSV. This can be created using a spreadsheet program, a text editor, or a custom filter program to convert data from one format to another.

```
1,0,1,0,1,0,0,1,0,1,1,1<CR>
1,0,0,0,1,1,0,1,0,1,0,1<CR>
0,0,1,0,1,0,1,1,0,0,1,1<CR>
```

NOTE. Bit pattern data must have at least 64 words. Above pattern data can not be read into the DG2020A. Note that this is a simple example.

Once the data words have been imported, parameters including clock rate, output levels and inter-channel timing need to be set since the CSV format does not transfer this information. After all operating parameters have been set, the entire pattern can be stored on a floppy for non-volatile storage. The entire pattern will fit on one floppy since the DG2020A uses an instrument specific binary format that is more compact than ASCII format.

Importing Large Data Files. It is possible to create a CSV file that is larger than the capacity of the 3.5 inch floppy disk which has a capacity of 1.2 Megabytes. An extreme example is a 36 bit wide word pattern that has 65536 (64k) words. In this example, the export file would be over 4 megabytes long. For the data to fit onto a floppy, the pattern must be segmented into 16k blocks (16384 words) and saved to individual floppies. To import the data do the following:

1. Insert the floppy with the first 16k into the drive.
2. Select **File** → **Import Data** and select a file to be imported.
3. Press the **OK** button. The Import Configuration pop-up menu displays. This menu allows you to configure how the data will be imported. In this example, only the Dest Start point will be modified.
4. Set the Dest Start point to zero for the first floppy.
5. Set the Dest Start point to 16536 for the second floppy.
6. Set the Dest Start point to 32768 for the third floppy.
7. Set the Dest Start point to 49152 for the fourth floppy.

Once the data words have been imported, parameters including clock rate, output levels and inter-channel timing need to be set since the CSV format does not transfer this information. After all operating parameters have been set, the entire pattern can be stored on a floppy for non-volatile storage. The entire pattern will fit on one floppy since the DG2020A uses an instrument specific binary format that is more compact than ASCII format.

Export Writes pattern data to mass memory (floppy disk). Data is written either as CSV data or as Tektronix AWG2000 Series waveform data. The write method is specified by setting a parameter in a popup menu.

NOTE. Icon data and hardware setup data are not saved in the output AWG2000 Series waveform data. When this data is read in to an AWG2000 Series instrument, default setup data will be added. PCs and some other systems may not be able to read this data directly.

Operation. Write pattern data to mass memory

Bottom button	Popup menu	Side button
Insert a write-enabled floppy disk in the floppy disk drive.		
File		Export Data
	Select the format of the data to be written (either CSV data or AWG2000s Waveform data).	OK
	Enter the file name for the data to be written.	OK
	Change the parameters as required.	OK

Popup Menu. Figure 3-7 shows the configuration windows for the two formats.

Pattern data will be written for bits for which this indicator is on.

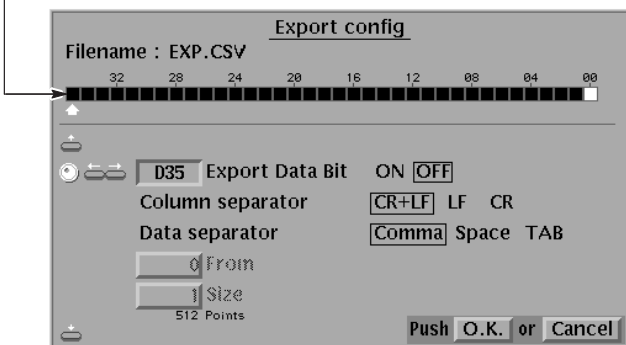

CSV Format

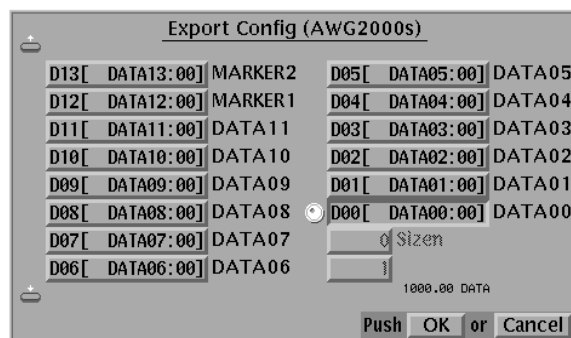

AWG2000 Series Format

Figure 3-7: Export config menu

When CSV format is selected, the instrument displays a menu for selecting which bits should be written to the file, delimiter symbols, and other parameters. Table 3-4 describes the parameter items that are set using this menu.

Table 3-4: Export parameters

Parameter	Function
Export Data Bit	Specifies the data bits to be written to the pattern data. Bits for which this indicator is on are written. Bits can be selected using the general purpose knob, and the on/off state can be changed with the left and right arrow buttons. Consecutive bits can be turned on or off using the 1 and 0 numeric keys.
Column separator	Sets the line separator symbol. The delimiter symbols are usually used as follows: CR+LF: MS-DOS and Windows LF: UNIX CR: Macintosh
Data separator	Sets the inter-bit delimiter. Comma, space, or tab can be selected for this parameter. Comma is the most common setting.
From	This field is valid when Entered is specified for the Region in the sub menu. It specifies the starting position for the data written.
Size	This field is valid when Entered is specified for the Region in the sub menu. It specifies the number of data points written.

When the AWG2000 Series format is selected, a menu that allocates data for a total of 14 bits, **MARKER 1** and **2** and **DATA00** to **DATA11**, is displayed. Use the arrow buttons to select the AWG2000 Series bit and use the general purpose knob to allocate the DG2000 bit. Allocate all bits to be written by repeating this operation.

Sub Menu

Item	Function
Set All Data bits (CSV only)	Sets the data bit write settings for all data bits.
Clear All Data bits (CSV only)	Clears the data bit write settings for all data bits.
Region	When this setting is set to All, the whole data area is written, and when it is set to Entered, the data in the area specified by From and Size is written.

New Initializes all data, including the pattern data, the block divisions, and the sequence data to the default state.

Operation. Initialization for pattern data creation

Bottom button	Popup menu	Side button
File		New
		OK

Settings Menu

The settings menu sets all the **EDIT** menu internal settings. It supports the following operations.

- Setting the reference mark
- Setting the reference group
- Setting the memory size
- Setting the arrow button operating mode
- Setting the display type (format)

The item to be set is selected from the popup list using the general purpose knob. Figure 3-8 shows the popup menu.

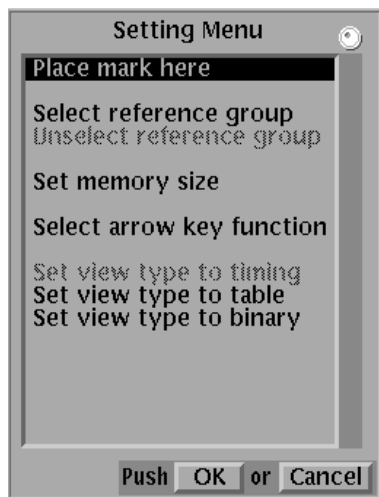

Figure 3-8: Settings popup menu

Place Mark Here

Sets the reference mark at the current cursor position. The reference mark is displayed as an "M" on the point scale as shown in Figure 3-9. The interval (Δ) between the set reference mark and the current cursor position is displayed as a point difference and as a time difference.

The reference mark only specifies the origin of the delta display. It does not affect the pattern data definition itself.

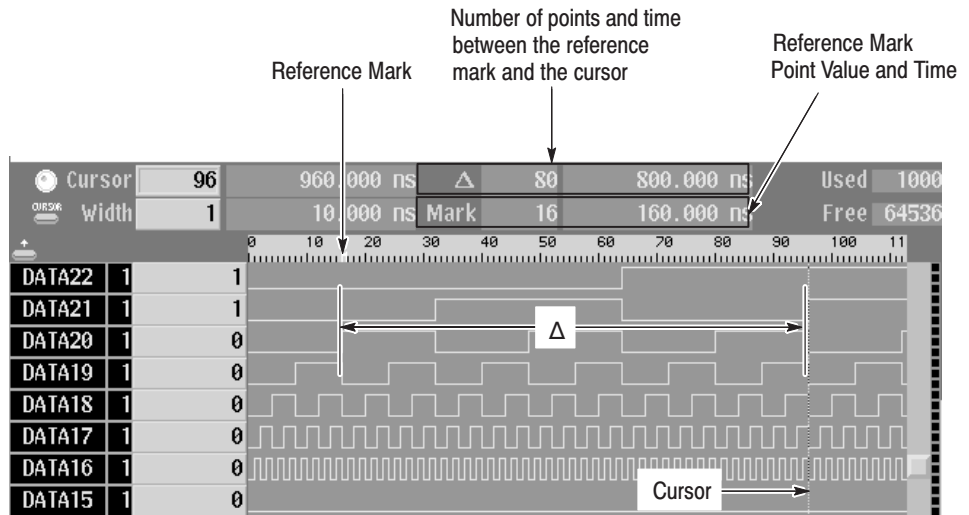

Figure 3-9: Reference mark "M" display

Operation. Set the reference mark

Bottom button	Popup menu	Side button
Move the knob icon to the Cursor window in the upper left of the screen.		
Set the cursor to the reference point using the general purpose knob or the numeric keys.		
Settings	Place mark here	OK

Select Reference Group

Sets the group to be used as the reference for editing pattern data. The selected reference group will also be displayed at the top of the pattern data edit screen in timing display, or at the left of the screen in table display. Figure 3-10 shows an example in which DATA00 has been set to be the reference group.

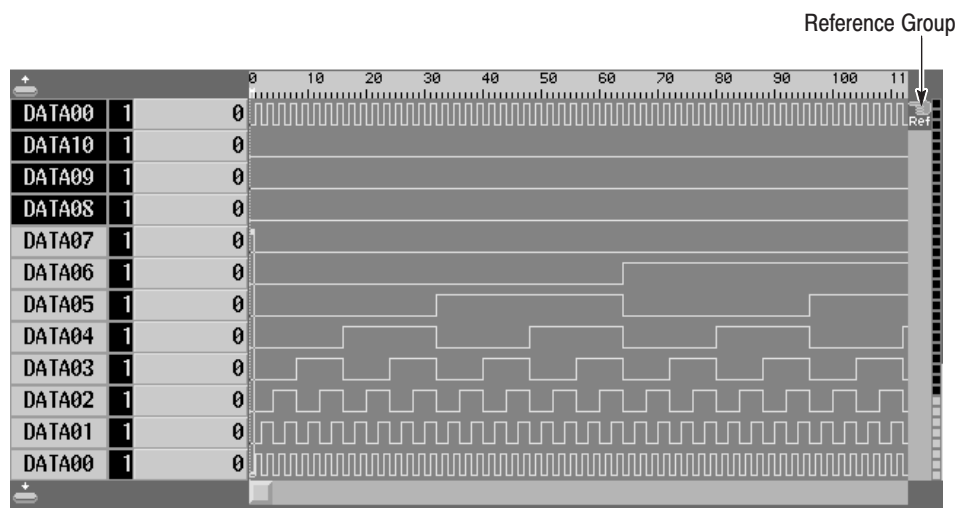

Figure 3-10: Reference group setting (timing display)

Operation. Set the reference group

Bottom button	Popup menu	Side button
Settings	Select reference group	OK
	Select the group to be used as the reference.	OK

Unselect Reference Group

Clears the reference setting for the group set with **Select reference group**.

Operation. Clear the reference group

Bottom button	Popup menu	Side button
Settings	Unselect reference group	OK

Select Memory Size

Sets the pattern data memory size. The size can be set to a value in the range 64 to 65536. In some cases the memory size setting is changed by operations that change the block length. Items that exceed the memory size due to editing operations are either ignored or discarded.

Operation. Set the memory size

Bottom button	Popup menu	Side button
Settings	Set memory size	OK
	Set the number of points.	OK

Select Arrow Key Function

Defines the actions of the arrow buttons. The term arrow button, refers to the left and right arrow buttons for timing display, and the up and down arrow buttons for table and binary display. Arrow button actions include those associated with cursor movement and those associated with editing operations. Also note that the arrow button action is sometimes changed automatically by the **Execute Action** functions described on page 3-28. Figure 3-11 shows an action display within the timing display

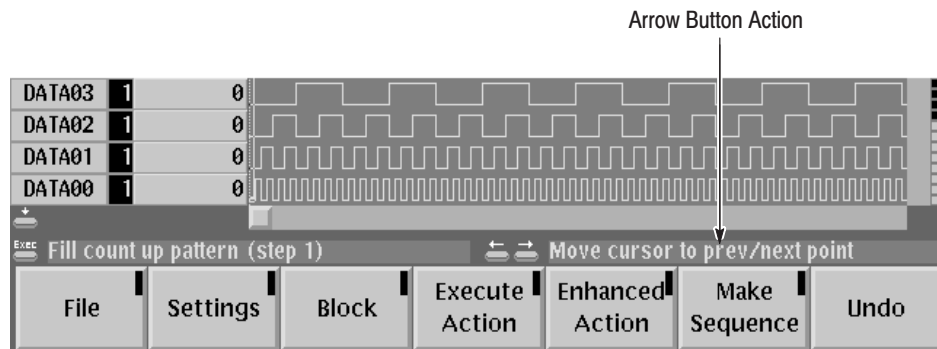

Figure 3-11: Arrow button action display (timing display)

Operation. Set the arrow button action

Bottom button	Popup menu	Side button
Settings	Select arrow key function	OK
	Select the arrow button action.	OK

Popup Menu. Use the general purpose knob to select one of the following actions from the displayed popup menu. Items that currently cannot be used are dimmed as shown in Figure 3-12.

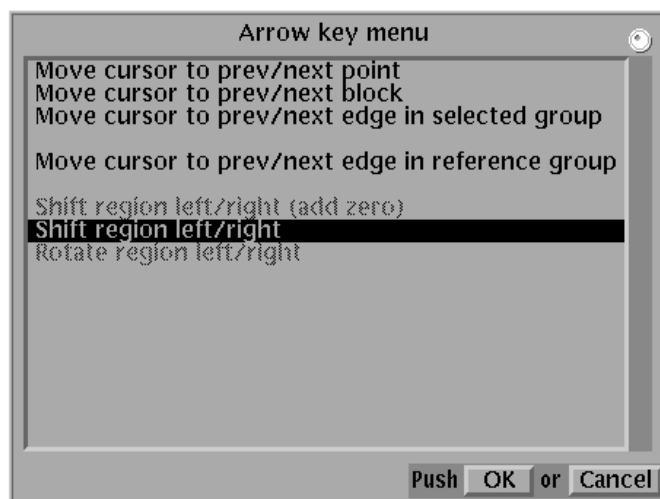

Figure 3-12: Arrow button operation menu

Table 3-5: Arrow button functions

Arrow button functionality	Selection item	Description
Cursor movement	Move cursor to prev/next index	Moves the cursor to the immediately preceding or immediately following data point.
	Move cursor to prev/next block	Moves the cursor to the start of the block immediately preceding or immediately following the block where the cursor is currently located.
	Move cursor to prev/next edge in selected group	Moves the cursor to the next place in the currently selected group where the data value changes. This function cannot be used if multiple groups are selected.
	Move cursor to prev/next edge in reference group	Moves the cursor to the next place where the data value changes in the reference group set by the Select reference group item in the Settings menu.
Cursor movement associated with editing operations	Shift region left/right (add zero) (Timing display only) Shift region up/down (add zero) (Table and binary display only)	The data in the edit area is shifted left (or up) or right (or down) one point at a time. See the descriptions of the Execute Action menu Shift region left/right (add zero) and Shift region up/down (add zero) items.
	Shift region left/right (Timing display only) Shift region up/down (Table and binary display only)	Except for the data point at the end of the editing area, the data in the editing area is shifted left (or up) or right (or down) by 1 point at a time. See the descriptions of the Execute Action menu Shift region left/right and Shift region up/down items.
	Rotate region left/right (Timing display only) Rotate region up/down (Table and binary display only)	The data in the editing area is rotated left (or up) or right (or down) by 1 point at a time. See the descriptions of the Execute Action menu Rotate region left/right and Rotate region up/down items.

Setting Pattern Data Display Format

Sets the pattern data display format. The display format is selected from the following options.

- Timing display
- Table display
- Binary display

Table 3-6 present descriptions and examples of the pattern data display formats.

Operation. Set the pattern data display format

Bottom button	Popup menu	Side button
Settings	Select from the following items. Set view type to timing Set view type to table Set view type to binary	OK

Table 3-6: Pattern data display format

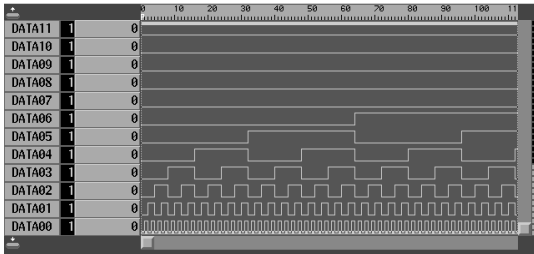
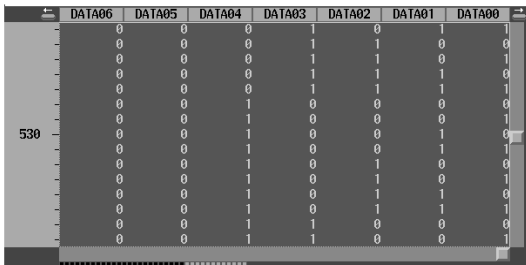
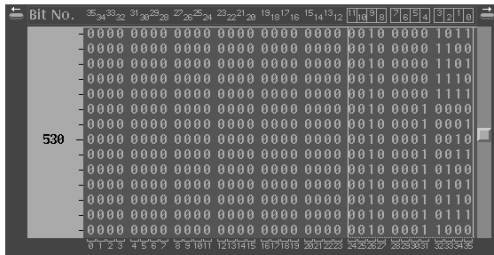
Display format setting item	Description
Set view type to timing	<p>Sets the pattern data display method to the timing format. Hexadecimal editing is possible if groups are defined.</p> 
Set view type to table	<p>Sets the pattern data display method to the table format. Hexadecimal editing is possible if groups are defined.</p> 
Set view type to binary	<p>Sets the pattern data display method to the binary format.</p> 

Block Menu

The block menu is used to define packets of data called blocks and the cursor movement with respect to those blocks. The items to be set are selected from a popup list using the general purpose knob.

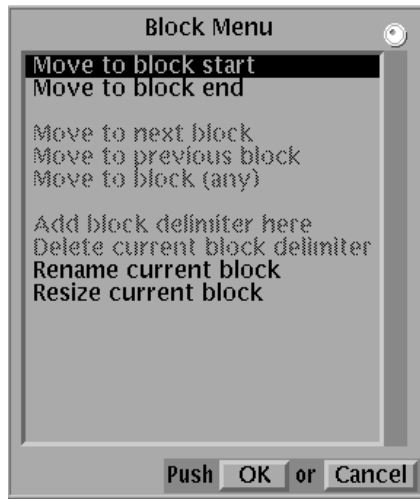

Figure 3-13: Block popup menu

Block Relative Cursor Movement. Moves the cursor relative to the current block. Table 3-7 provides a description for each item in the Block popup menu.

Table 3-7: Block relative cursor movement

Select item	Description
Move to block start	Moves the cursor to the start of the block in which the cursor is currently located.
Move to block end	Moves the cursor to the end of the block in which the cursor is currently located.
Move to next block	Moves the cursor to the start of the block following the block in which the cursor is currently located.
Move to previous block	Moves the cursor to the start of the block preceding the block in which the cursor is currently located.
Move to block (any)	Moves the cursor to the start of a block selected from a list of blocks in a popup menu.

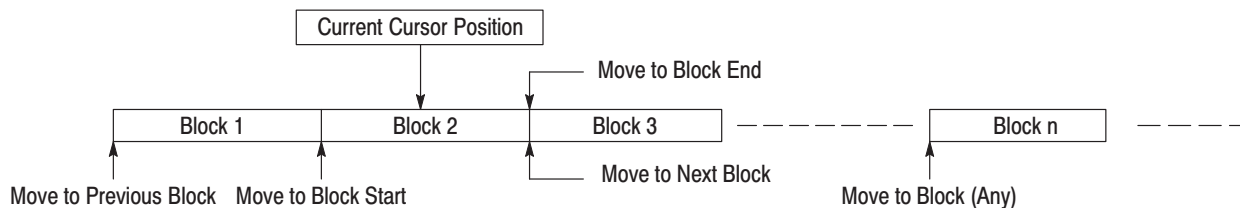

Figure 3-14: Block relative cursor movement

Operation. Block Relative Cursor Movement

Bottom button	Popup menu	Side button
Block	Select from the following items. Move to block start Move to block end Move to next block Move to previous block Move to block (any)	OK
	Select the block to move to. (Move to block (any) only)	OK

Add Block Delimiter Here

Sets a block delimiter at the current cursor position. The delimiter point becomes the starting point of the next new block. The block delimiter is marked on the point scale.

NOTE. A block delimiter cannot be set at a point that is not at least 64 points away from both the start and the end of the block in which the delimiter is being set.

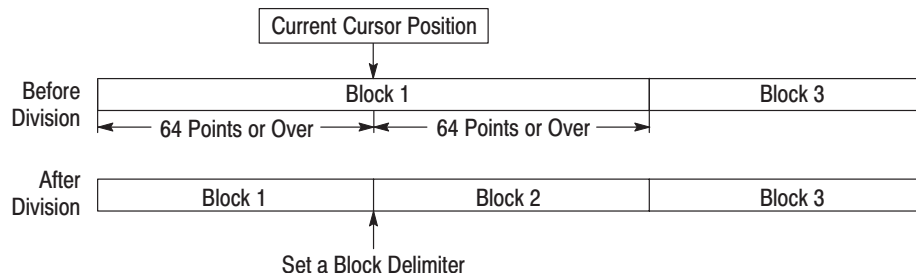

Figure 3-15: Divide a block

Operation. Divide a block

Bottom button	Popup menu	Side button
Move the knob icon to the Cursor window in the upper left of the screen.		
Move the cursor to the location where the block delimiter is to be placed.		
Block	Select Add block delimiter here.	OK
		Clear String
	Input a block name.	OK

Delete Current Block Delimiter

Deletes the block delimiter between the current block and the preceding block to combine the block with the immediately preceding block.

NOTE. To delete the block delimiter, at least one block must exist before the current block.

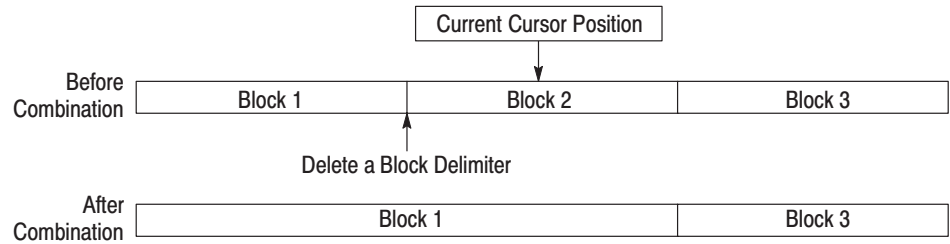

Figure 3-16: Combine blocks

Operation. Combine blocks

Bottom button	Popup menu	Side button
Move the knob icon to the Cursor window in the upper left of the screen.		
Move the cursor to the block whose block delimiter is to be deleted.		
Block	Select Delete current block delimiter.	OK

Rename Current Block

Changes the name of the block at the current cursor position.

Operation. Change a block name

Bottom button	Popup menu	Side button
Move the knob icon to the Cursor window in the upper left of the screen.		
Move the cursor to the block whose name is to be changed.		
Block	Select Rename current block.	OK
		Clear String
	Enter the new block name.	OK

Resize Current Block

Changes the size of the block at the current cursor position. The size of other blocks is not changed; the memory size is changed.

When increasing the size of the current block, only set a size that does not cause the total number of points to exceed the maximum memory size. Zero data corresponding to the increase in size is added at the end of the block.

When decreasing the size of the current block, data is deleted from the end of the block.

Note that the range of allowable block sizes starts at a minimum size of 64 points.

NOTE. Changes to the block size cannot be reversed with the *Undo* operation.

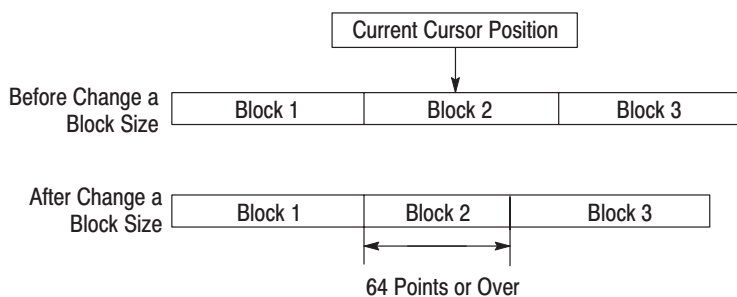

Figure 3-17: Change a block size

Operation. Change a block size

Bottom button	Popup menu	Side button
Move the knob icon to the Cursor window in the upper left of the screen.		
Move the cursor to the block whose size is to be changed.		
Block	Select Resize current block.	OK
	Enter the new block size.	OK

Execute Action Menu

The **Execute Action** menu sets up a variety of editing operations. The editing operation is selected from the **Action Menu** (a popup menu, see Figure 3-18) using the general purpose knob. The editing operation is applied to the editing object area when the front panel **EXECUTE** button is pressed.

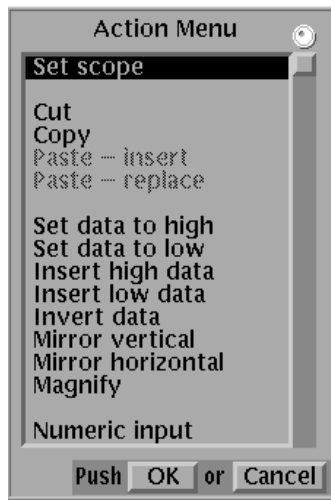

Figure 3-18: Action popup menu

The area of the pattern data that will be the object of the edit may consist of the range enclosed by the area cursor, and may consist of the area following the cursor, depending on the selected editing operation.

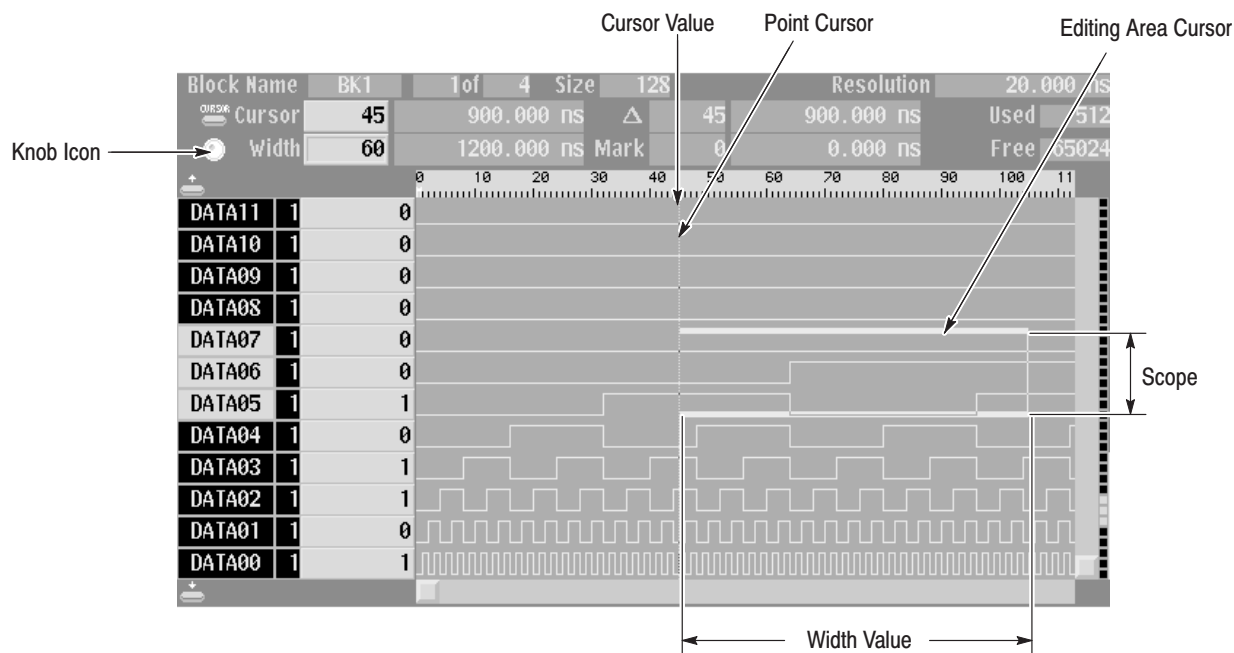

Figure 3-19: Editing area range

The location or range that the editing operation applies to is set as follows:

- Point Position Input.** The range is determined by the **Width** value. To set the width value, move the knob icon to the **Width** value display by pressing the front panel **CURSOR** button. Then enter the value with the general purpose knob or the numeric keys.

To set the position move the knob icon next to the **Cursor** position display by pressing the front panel **CURSOR** button. Then enter the value with the general purpose knob or the numeric keys.

- Group/bit Input.** The groups or bits to be included in the range are set using the **Set scope** item in the **Execute Action** menu.

Bottom button	Popup menu	Side button
Execute Action	Select Set scope.	OK
	Determine the scope.	OK

When changing the groups or bits in the editing range, the buttons used will differ depending on the display format. Use the up and down arrow buttons for timing display format, and use the left and right arrow buttons for table and binary display formats.

- **Editing Operation.** Use the following editing procedure when the area enclosed by the editing area cursor is the object of the editing operation.

Bottom button	Popup menu	Side button
Execute Action	Select the editing operation.	OK
Set the value of the Cursor item at the upper left of the screen.		
Set the value of the Width item at the upper left of the screen.		
Set the groups/bit.		
		EXECUTE

Use the following editing procedure when the area following the cursor is the object of the editing operation.

Bottom button	Popup menu	Side button
Execute Action	Select the editing operation.	OK
Determine the value of the Cursor item at the upper left of the screen.		
Determine the group/bit.		
		EXECUTE

NOTE. Pressing the **CLEAR MENU** button clears the selected editing operation.

Set Scope

Sets the range of groups or bits that will be the object of an editing operation executed by the **EXECUTE** button.

The meaning of a scope element differs depending on the pattern data display format. For the timing and table display format, a element group is a single scope element. For the binary display format a single bit is a single scope element. Therefore in timing and table display, the number of bits that will be edited may change depending on which groups are within the selected range, even though the scope does not change as it is moved.

Operation. Set the scope

Bottom button	Popup menu	Side button
Execute Action	Select Set scope.	OK
	Set the number of scope elements using the knob.	OK

Cut The cursor becomes the area cursor. The data in the editing range is deleted, and data is filled in at the end of memory in an amount equal to the amount of data deleted. The filled data (the tail) is set to 0. Note that the deleted data is inserted in the paste buffer and can be used as paste data.

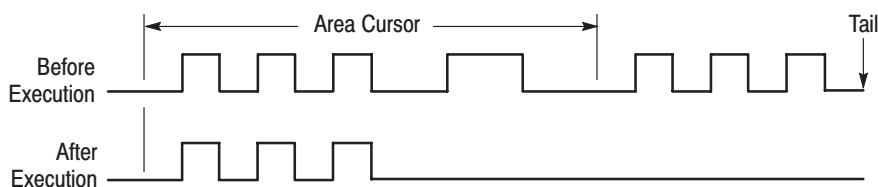

Figure 3-20: Cut

Copy The cursor becomes the area cursor. The data in the editing range is copied to the paste buffer. The pattern data itself is not affected.

Paste-insert Inserts the data in the paste buffer at the current cursor position. The data after the cursor is moved to the rear by the length of the pasted data. After the data is moved, data that exceeds the set memory size is lost.

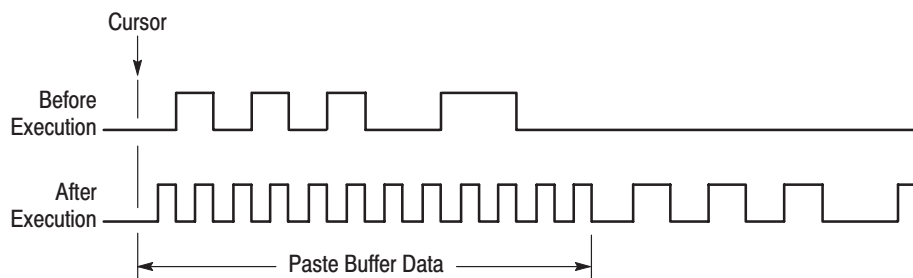

Figure 3-21: Paste - insert

Paste-replace Writes the data in the paste buffer over the data starting at the current cursor position.

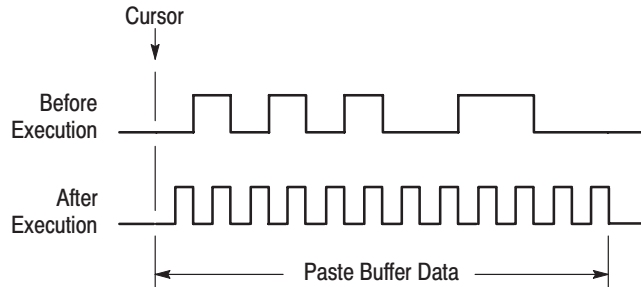

Figure 3-22: Paste - replace

Set Data To High The cursor becomes the area cursor. All the data bits in the editing area are set to 1.

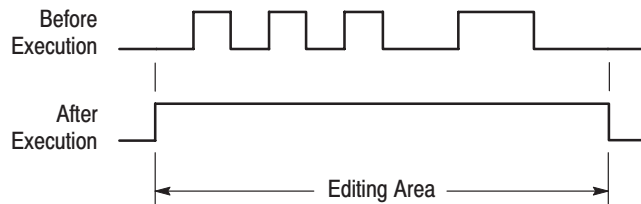

Figure 3-23: Set data to high

For example, this operation will set the value of a 3-bit group data item to 7H (hexadecimal).

Set Data To Low The cursor becomes the area cursor. All the data bits in the editing area are set to 0.

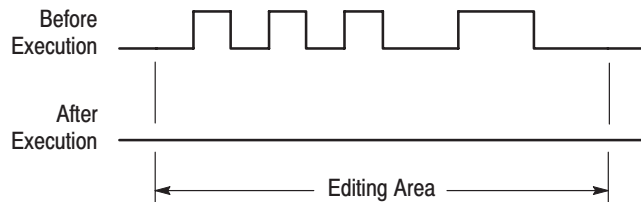

Figure 3-24: Set data to low

Insert High Data

The cursor becomes the area cursor. The data following the cursor is moved to the rear by the amount specified for the editing area and the data in the editing area is set to 1.

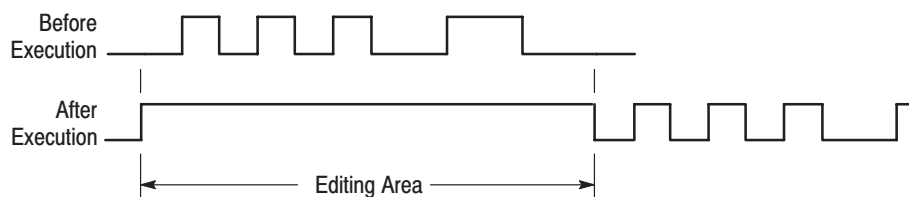

Figure 3-25: Insert high data

Insert Low Data

The cursor becomes the area cursor. The data following the cursor is moved to the rear by the amount specified for the editing area and the data in the editing area is set to 0.

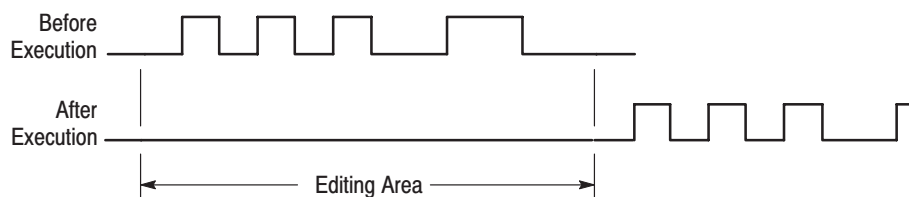

Figure 3-26: Insert low data

Invert Data

The cursor becomes the area cursor. The data in the editing area is inverted, i.e. 0 becomes 1, and 1 becomes 0.

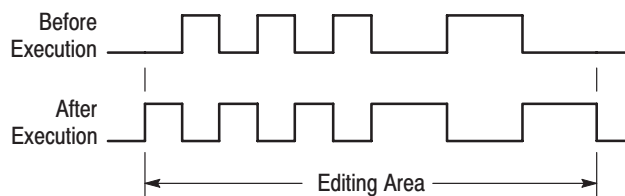

Figure 3-27: Invert data

For example, this operation will set the value of a 3-bit group whose original value was 4H (hexadecimal) to 3H.

Original data: 100 (binary) (= 4H)

Inverted data: 011 (binary) (= 3H)

Mirror Vertical

The function described here is for timing display format. The cursor becomes the area cursor. The area specified as the editing area is reordered in the group/bit direction in a mirror-image manner. This editing operation operates on bit units regardless of any group definitions. In display formats other than timing display (i.e., table and binary), the reordering is performed in the point direction.

Before Execution

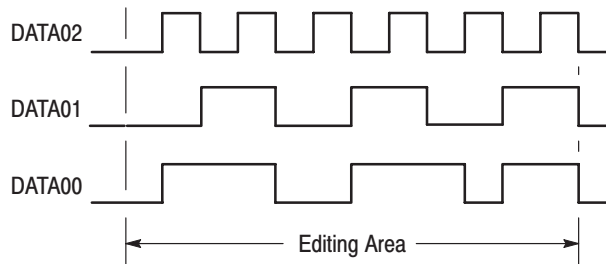

After Execution

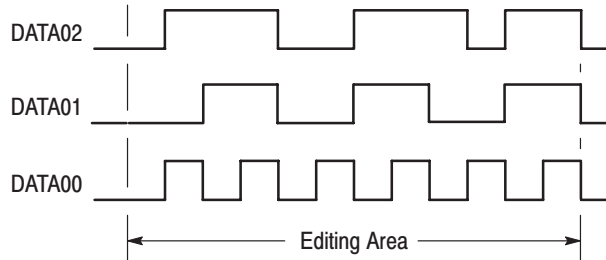

Figure 3-28: Mirror vertical

Mirror Horizontal

This function is for timing display format. The cursor becomes the area cursor. The area specified as the editing area is reordered in the point direction in a mirror-image manner. In display formats other than timing display (i.e., table and binary), the reordering is performed in the group/bit direction.

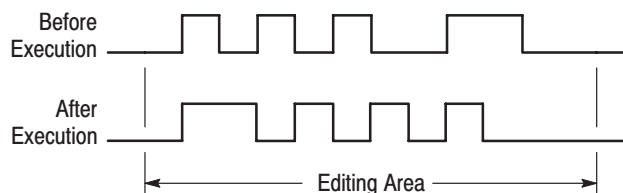

Figure 3-29: Mirror horizontal

Magnify

The cursor becomes the area cursor. The data in the area specified as the editing area is magnified in the direction of the time axis. This function has one parameter, the magnification factor (**Mag Factor**). This can be set to any integer from 2 to 100.

For example, if **Mag Factor** is 2, then magnifying a data range with the data 0101 would give the data 00110011. This editing operation repeats each data item the number of times specified by the **Mag Factor** parameter.

The data following the edit area is moved to the rear from the editing area by the amount of the data increased due to the magnification. The data in the tail that exceeds the memory size is lost.

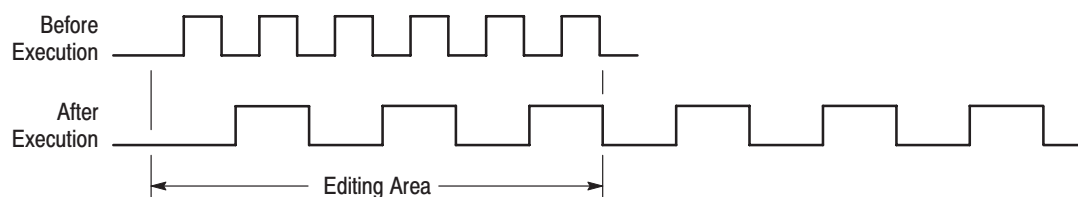

Figure 3-30: Magnify

Numeric Input

The cursor switches to the point cursor, and the input position is indicated on the display. Data can then be changed by input of numeric values. As data is input, existing data at the input position is overwritten.

After selecting **Numeric input** from the **Action Menu**, step is set using the **Points/Step** popup window. A 'step' is the number of points that are set for each number that is input.

Then, the **EXECUTE** button is pressed to start input. Front panel keys are then pressed to set the required data values. The kind of input that is possible differs according to the display format, as shown in Table 3-8.

Table 3-8: Numeric input differences

Display method	Input position	Numeric input type
Timing	Display of that group data value is selected.	Hexadecimal
Table	Data at the object position is displayed highlighted (bright).	Hexadecimal
Binary	Data at the object position is displayed highlighted (bright).	Binary

Note that depending on how many bits there are in the group at which the input is currently directed, it is sometimes not possible to input the full range of hexadecimal digits. For instance, if the group is only three bits wide, it is not possible to input a digit larger than 7.

Input of each data value finishes, and the data is set, when the number of input digits is sufficient to set all the bits in the group. There is no need to press the enter button.

When the scope is only one group deep (or one bit deep for binary format), the cursor moves along the data by the number of points in a step for each input operation. The next input operation will then set the data at the new cursor position for the same group.

However, when the scope is more than one group deep (or more than one bit deep for binary format), the cursor does not immediately move. Instead, the next input action will be directed at the next group down (or to the right). Only when input to the last group in the scope is complete does the cursor move along the data.

Operation. Actions for performing numeric input

Bottom button	Popup menu	Side button	Front panel button
Enhanced Action	Numeric input	OK	
Set the Points/Step using the general purpose knob.			
		OK	EXECUTE
Input data using numeric keys.			

Shifting The DG2020A provides several methods for the shifting of data in timing, table, or binary display.

Timing. In timing display you can shift data using any one of the following:

- Shift left (add zero)
- Shift right (add zero)
- Shift left
- Shift right

The cursor becomes the area cursor. The data inside the editing area is shifted one point to the left or right. Data that overflows the edit area is lost. If you select any one of the add zero selections, zeros are added at the right or left. If you select shifting without adding zeros, values added at the right or left are equal to the right or left-most values for each bit in the edit area when shifting started.

Figures 3-31, 3-32, 3-33, and 3-34 illustrate the different shifting selections for timing.

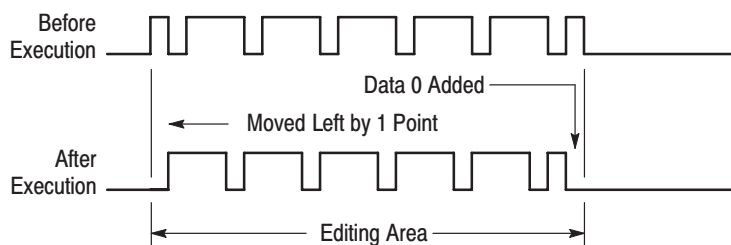

Figure 3-31: Shift left (add zero)

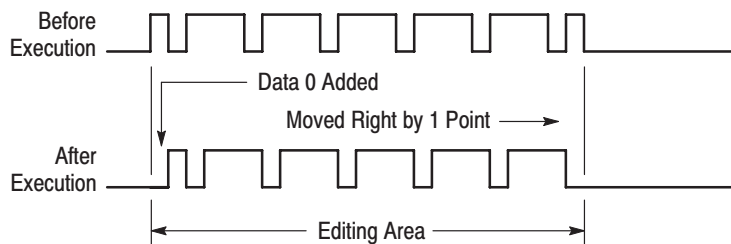

Figure 3-32: Shift right (add zero)

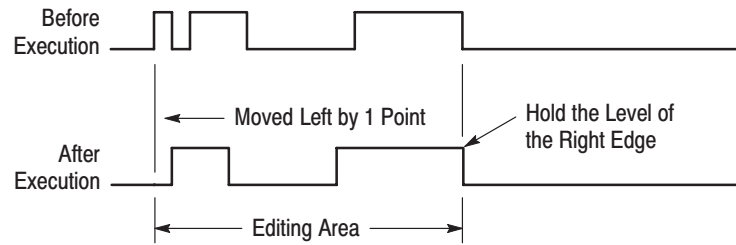

Figure 3-33: Shift left

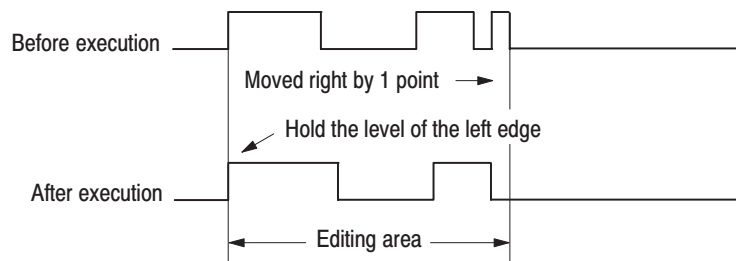

Figure 3-34: Shift right

If a shifting operation is selected when the **Select arrow key function** item is selected in the **Settings** menu, data can be shifted to the left or right with the arrow buttons.

Table and Binary. In the table and binary displays you can shift data using any of the following:

- Shift up (add zero)
- Shift down (add zero)
- Shift up
- Shift down

The cursor becomes the area cursor. The data inside the editing area is shifted one point up or down. Data that overflows the edit area is lost. If you select any one of the add zero selections, zeros are added to the top or bottom. If you select shifting without adding zeros, values added at the top or bottom are equal to the top or bottom-most values for each bit in the edit area when shifting started.

If a shifting operation is selected when the **Select arrow key function** item is selected in the **Settings** menu, data can be shifted up or down with the arrow buttons.

Rotating The DG2020A provides several methods for rotating data in timing, hexadecimal, or binary display.

Timing. In timing display you can rotate data using any one of the following:

- Rotate left
- Rotate right

The cursor becomes the area cursor. The data inside the editing area is rotated one point to the left or right. Data that overflows the editing area cycles around and is added at the left or right of the edit area. Figures 3-35 and 3-36 illustrate the different rotating selections for timing.

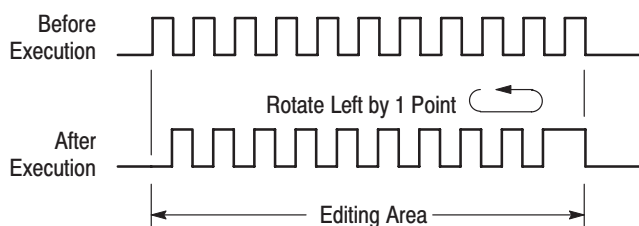

Figure 3-35: Rotate left

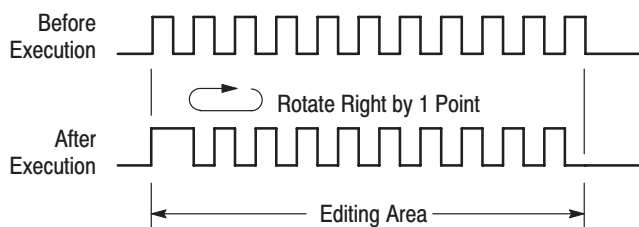

Figure 3-36: Rotate right

If **Rotate region left/right** is selected when the **Select arrow key function** item is selected in the **Settings** menu, data can be rotated to the left or right with the arrow buttons.

Table and Binary. In the table and binary displays you can rotate data using any of the following:

- Rotate up
- Rotate down

The cursor becomes the area cursor. The data inside the editing area is rotated by one point up or down. Data that overflows the editing area cycles around and is added to the top or bottom of the edit area.

If **Rotate region up/down** is selected when the **Select arrow key function** item is selected in the **Settings** menu, data can be rotated to the up or down with the arrow buttons.

Creating Standard Pattern Data

Table 3-9 and Figure 3-37 present descriptions and examples of the standard pattern data.

Table 3-9: Standard pattern data descriptions

Standard pattern data	Description
Binary up counter	Creates a binary up counter data pattern. The cursor becomes the area cursor. The number of bits in the counter is the total number of bits in the group set up with the Set scope item in the Execute Action menu. When Binary up counter is selected, the instrument asks for the Points/Step value. This value sets the number of data points per counter step. When the counter reaches its maximum value, the value returns to 0 and it repeats the count-up operation.
Binary down counter	The use is the same as Binary up counter. The action is the same except that a binary down counter is created., and when the counter reaches 0, the value returns to its maximum value and it repeats the count-down operation.
Johnson counter	Creates a Johnson counter data pattern. When this menu item is selected, the instrument asks for the Points/Step value. This value sets the number of data points per counter step.
Graycode counter	Creates a Gray code counter data pattern. When this menu item is selected, the instrument asks for the Points/Step value. This value sets the number of data points per counter step.

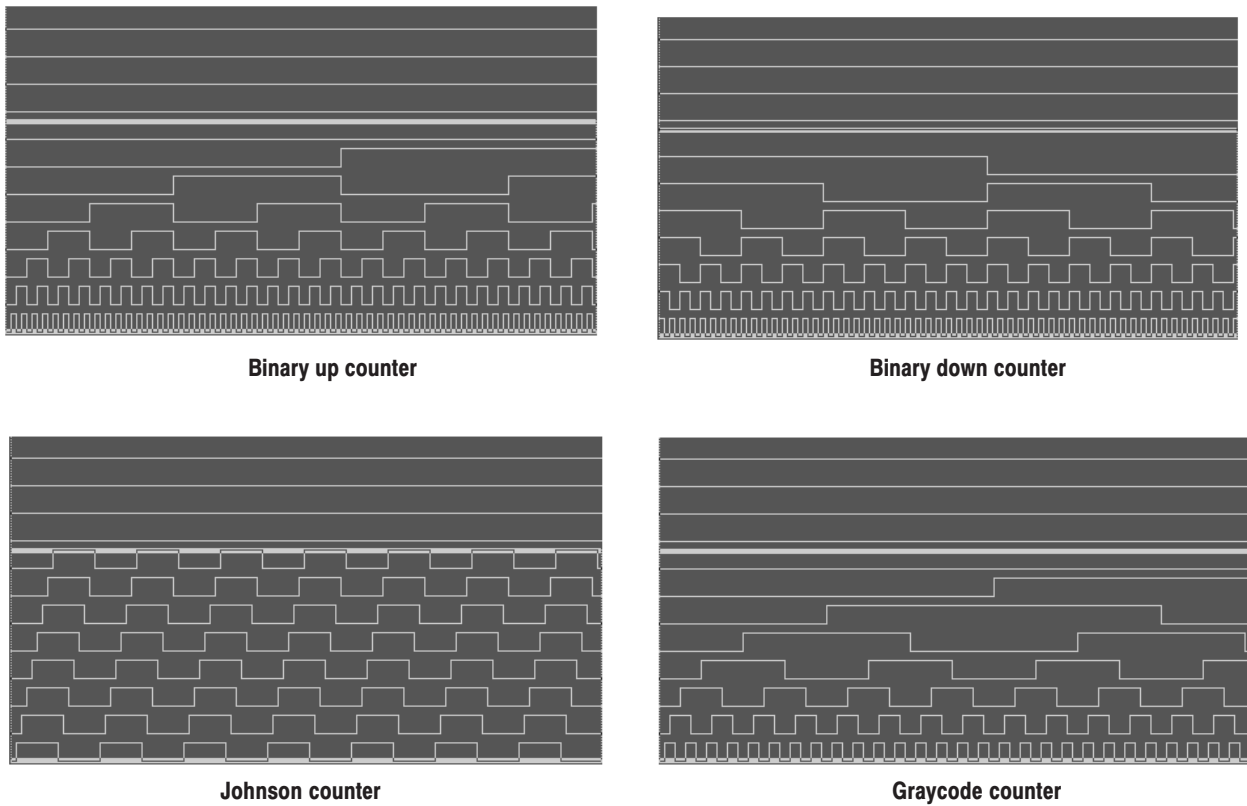

Figure 3-37: Standard pattern data

Operation. Creating the standard pattern data

Bottom button	Popup menu	Side button
Set the editing range in the point direction.		
Set the editing range in the group/bit direction.		
Execute Action	Select from the following items. Binary up counter Binary down counter Johnson counter Graycode counter	OK

Enhanced Action Menu

The **Enhanced Action** menu uses special editing functions. When **All** is selected from the **Region** side menu the whole area is edited, and when **Entered** is selected from the **Region** side menu, **From** and **Size** parameters can be specified.

Clock Pattern Generates a clock pattern. The edit object can be any bit. Figure 3-38 shows the creation of a clock pattern enclosed in a frame and the generation of the pattern in the target bit.

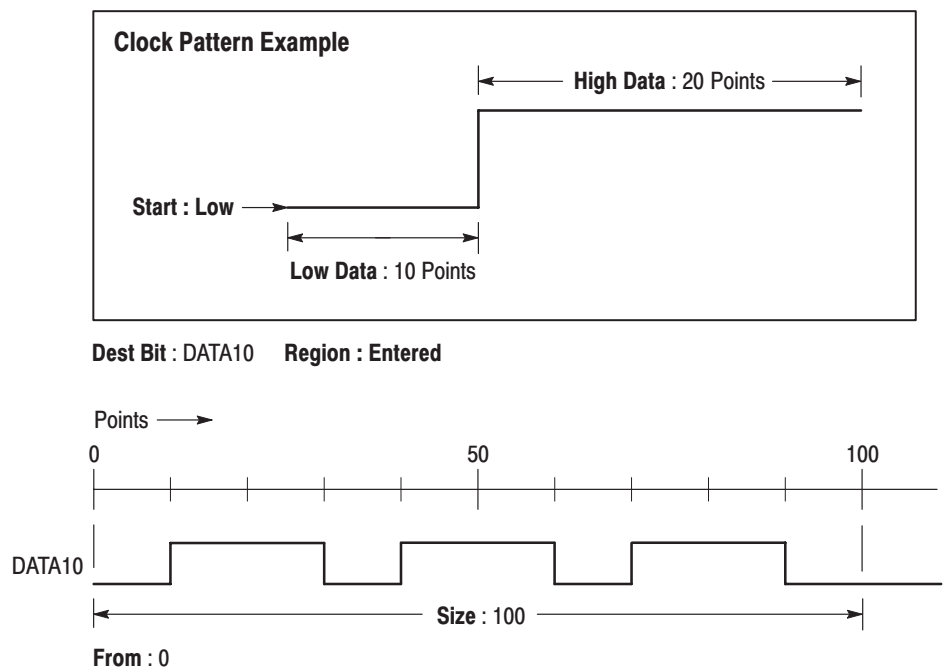

Figure 3-38: Creating the clock pattern

Popup Menu.**Figure 3-39: Clock pattern popup menu**

Table 3-10 describes the parameter items.

Table 3-10: Parameter items

Parameter item	Function
Low Data	The length (number of points) of the data 0 part of the clock pulse. The maximum is 100 points.
High Data	The length (number of points) of the data 1 part of the clock pulse. The maximum is 100 points.
Dest Bit	The bit in which to write the pattern.
From	When Entered was selected in the Region side menu item, specifies the first point in the bit from which the pattern is written.
Size	When Entered was selected as the Region side menu item, specifies the length (number of points) of the clock pattern.

Side Menu

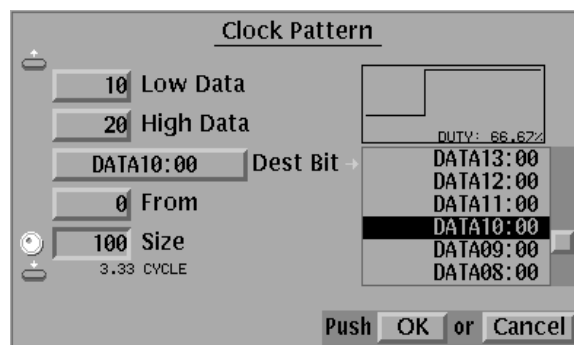
Menu item	Function
Start	Determines the state at pulse start. When Low is selected, the value will be 0. When High is selected, the value will be 1.
Region	The values All and Entered can be set. When All is selected, all of the Dest Bit memory is filled with the pattern. When Entered is selected, the pattern is written to the area specified by the From and Size parameters.

Operation. Generate a clock pattern

Bottom button	Popup menu	Side button
Enhanced Action	Clock Pattern	OK
		Region (Select All or Entered.)
		Start (Select Low or High.)
Set the parameters in the popup menu. (Low Data, High Data, Dest Bit, From, Size)		
		OK

Shift Register Generator

Sets up the configuration for the pseudo random pulse generator that uses a shift register.

The shift register pseudo random pulse generator consists of a register with between 1 and 32 bits and a feedback loop. This feedback loop takes the value that is shifted out of the register, performs the exclusive OR with one or more bits within the register, and places the result in the first bit of the register. The position at which an exclusive OR is set is called a tap, and certain tap configurations produce series that are the longest possible. The data generated by such a configuration is called an M-series. If the number of stages in the shift register is n , then an M-series pseudo random signal will have a length of $2^n - 1$.

Create a simple register and tap setup as follows:

- Register length: 3
- Register value: 101
- Set the tap with the **Maximum Length Taps** item.

Figure 3-40 shows the output for the above settings.

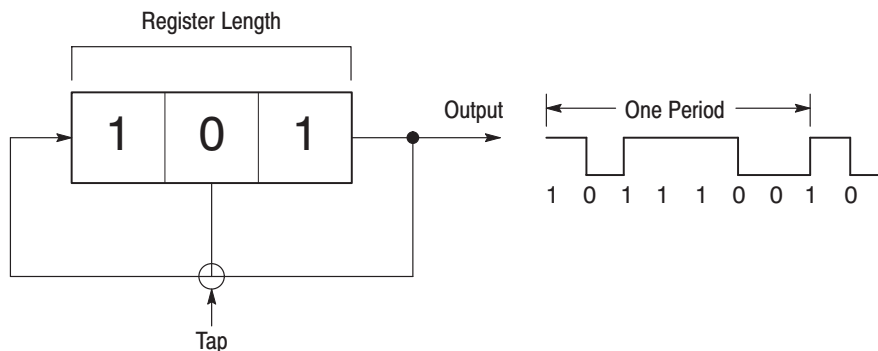

Figure 3-40: Register value and tap setting example

Popup Menu.

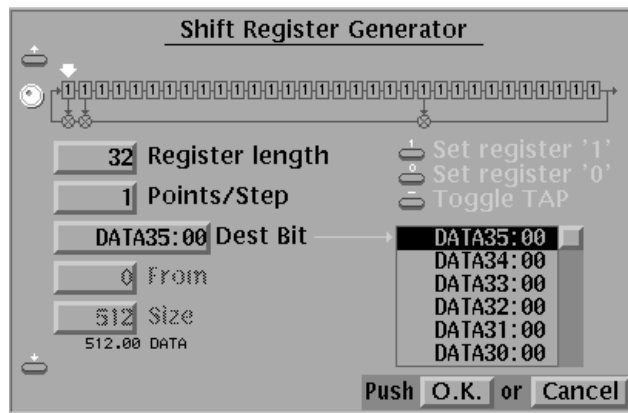

Figure 3-41: Shift register generator popup menu

Table 3-11 describes the parameter items.

Table 3-11: Shift register generator parameters

Parameter	Function
Register diagram	Use the 0 and 1 numeric keys to set the register's initial value. Use the "-" button to toggle taps.
Register Length	Sets the register length. The register length can be set to a value between 1 and 32.
Points/Step	The number of data points set for each shift of the register.
Dest Bit	The bit to which the pattern is written
From	When Entered was selected in the Region side menu item, specifies the first point from which the pattern is written.
Size	When Entered was selected in the Region side menu item, specifies the number of points into which the pattern is written.

Side Menu

Item	Function
Set All Registers	Sets the value of all the register bits to 1.
Maximum Length Tap	Sets the taps to positions such that the output becomes a tap M-series for the current register length. There are multiple tap combinations for M-series bit series. Each time the Maximum Length Tap button is pressed, the tap combination changes.
Region	The values All and Entered can be set. When All is selected, all of the Dest Bit memory is filled with the pseudorandom pulse pattern. When Entered is selected, the pattern is written to the area specified by the From and Size parameters.

Operation. Set the register value input and taps

Bottom button	Popup menu	Side button
Enhanced Action	Shift Register Generator	OK
		Region (Select All or Entered.)

Set the parameters in the popup menu.
(Register Length, Points/Step, Dest Bit, From, Size)

Use the general purpose knob to select bits for setting in the register.

Set the value of a bit in the register with the 0 and 1 numeric keys.

Set the tap on/off state for a bit using the "-" numeric key.

		OK
--	--	----

Logical Operation

Performs a logical operation between pattern data in two (source) bits, and replaces the data in a destination bit with the result. Figure 3-42 shows an example of a logical operation where the **AND** operator was selected.

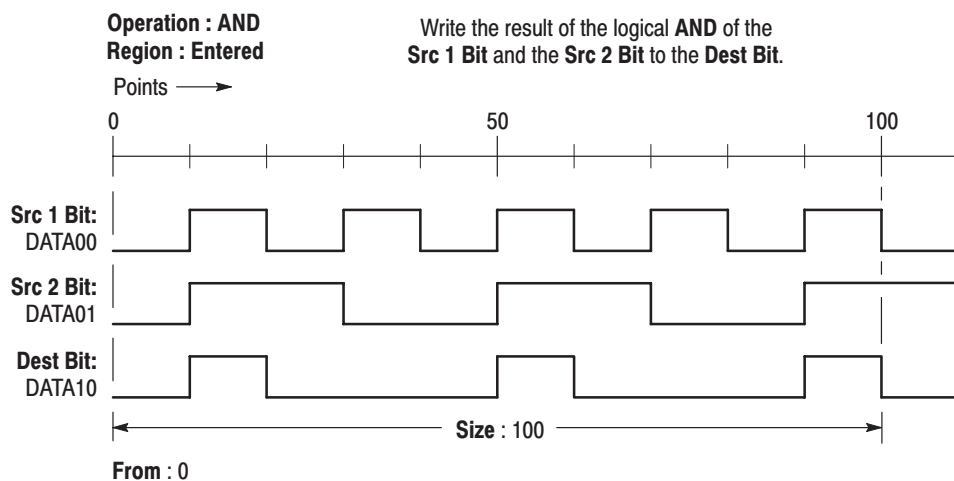

Figure 3-42: Logical operation example (AND)

Popup Menu.

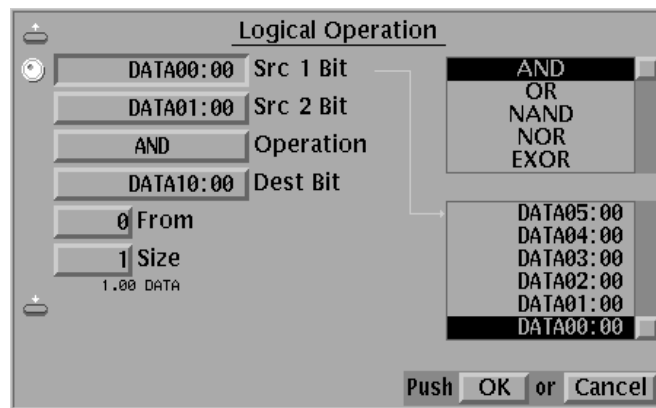

Figure 3-43: Logical operation popup menu

Table 3-12 describes the parameter items.

Table 3-12: Logical operation parameters

Parameter	Function	
Src 1 Bit	Specifies a bit that will be used as an operand to the operation.	
Src 2 Bit	Specifies the other bit that will be used as the other operand to the operation.	
Operation	Specifies the type of the operation.	
	Selection Item	Description
	AND	Logical AND
	OR	Logical OR
	NAND	Logical NAND
	NOR	Logical NOR
	EXOR	Logical exclusive OR
EXNOR	Logical exclusive NOR	
Dest Bit	The bit to which the result pattern is written	
From	When Entered was selected in the Region side menu item, specifies the first point in the bit from which the pattern is written.	
Size	When Entered was selected in the Region side menu item, specifies the number of points in the bit in which the pattern is written. The Maximum 9999 points can be entered. Entering 0 causes to quit the popup menu.	

Operation. Apply a logical operation to two data items

Bottom button	Popup menu	Side button
Enhanced Action	Logical Operation	OK
		Region (Select All or Entered.)
Set the parameters in the popup menu. (Src 1 Bit, Src 2 Bit, Operation, Dest Bit, From, Size)		
		OK

Bit Operation Copies or moves data between bits in the specified area.

Popup Menu.

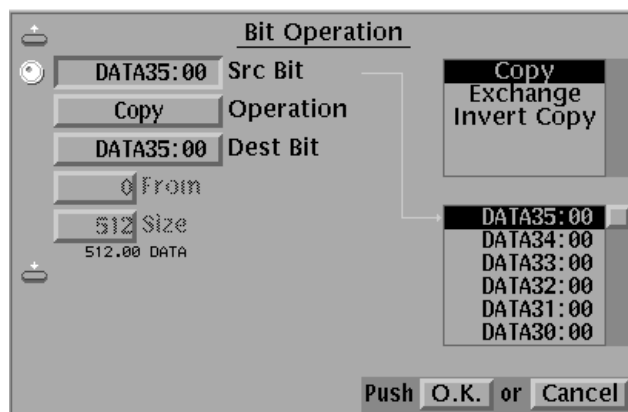

Figure 3-44: Bit operation popup menu

Table 3-13 describes the parameter items.

Table 3-13: Bit operation parameters

Parameter	Function	
Src Bit	Specifies the source data for the operation.	
Operation	Specifies the type of the operation.	
	Selection item	Description
	Copy	Copies the data, overwriting the destination data.
	Exchange	Exchanges the data in the source and destination bits.
	Invert copy	Copies the data. However, logically inverts the data before overwriting the destination data.
Dest Bit	The bit to which the pattern is written.	
From	When Entered was selected in the Region side menu item, specifies the first point in the bit from which the pattern is written.	
Size	When Entered was selected in the Region side menu item, specifies the number of points in the bit in which the pattern is written. The Maximum 9999 points can be entered. Entering 0 causes to quit the popup menu.	

Operation. Move or copy pattern data

Bottom button	Popup menu	Side button
Enhanced Action	Bit Operation	OK
		Region (Select All or Entered.)
Set the parameters in the popup menu. (Src Bit, Operation, Dest Bit, From, Size)		
		OK

Serial Code Converter

Converts data in the source by writing specified output data to the destination as one of a set patterns is found in the source data.

Refer to *Conversion Table Examples* on page C-6 for examples of how to convert pattern data to different format.

Popup Menu. The menu for setting the bit and area that will be the code conversion source data, and the bit and area where the result of the code conversion will be written is displayed using the following operation. (See Figure 3-45.) Select the item with the up and down arrow buttons, and use the general purpose knob and the numeric keys to set the parameter value.

Bottom button	Popup menu	Side button
Enhanced Action	Serial Code Converter	OK

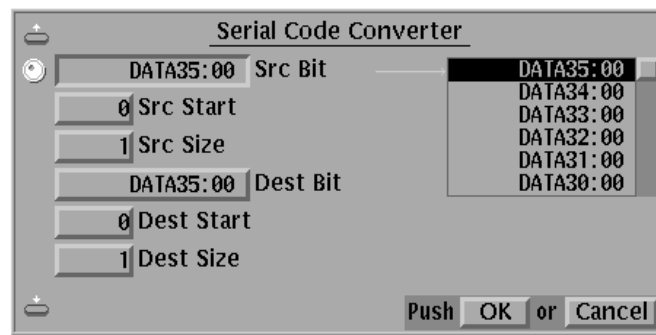

Figure 3-45: Serial code converter menu

Table 3-14 describes the parameter items.

Table 3-14: Serial code converter parameters

Parameter	Function
Src Bit	Specifies the bit from which the source data will be read.
Src Start	Specifies the point from which reading the source data will begin.
Src Size	Specifies the number of points of source data that will be read.
Dest Bit	Specifies the bit into which the converted data will be written.
Dest Start	Specifies the point from which converted data will be written.
Dest Size	Specifies the number of points of converted data that will be written.

Pressing the **OK** side button starts the conversion.

Side Menu

Menu item	Function
Load Table Data1	Reads in a code conversion table from mass memory. The file will be an ASCII file with the extension .TBL. The operation is identical to that for Load Data & Setup from the File menu.
Save Table Data	Writes a code conversion table to mass memory. The file must be an ASCII file with the extension .TBL. The operation is identical to that for Save Data & Setup from the File menu.
Edit Table Data	Edits a code conversion table. This is explained below.

Code Conversion Table Editing. Figure 3-46 shows the **Edit Code Table** menu, which is displayed when the **Edit Table Data** side menu item is selected. The **SOURCE CONDITION** section of this table defines the templates used for pattern matching. The instrument compares these templates with data sequences in the source data to find matching patterns.

NOTE. *The data code conversion table files are arranged in essentially the same manner as displayed on the table editing screen. In these files a comma is used to delimit fields, and CR+LF to delimit lines. No spaces appear in the file.*

Pattern matching is performed in order starting at the top of the table. Pattern matching is more reliable if templates with more bits (longer templates) appear towards the top of the table.

The matching process moves along the input data as follows. The current position is set to the start point, and the table is used to find a match for the data at that position. When a match is found, the output code for that template is written to the destination. The current position is then moved on by the width of the pattern in the **CURRENT** column. The process then repeats.

This continues until the destination is full. If the end of the input data is reached before the destination is full, the current position returns to the start point in the source data.

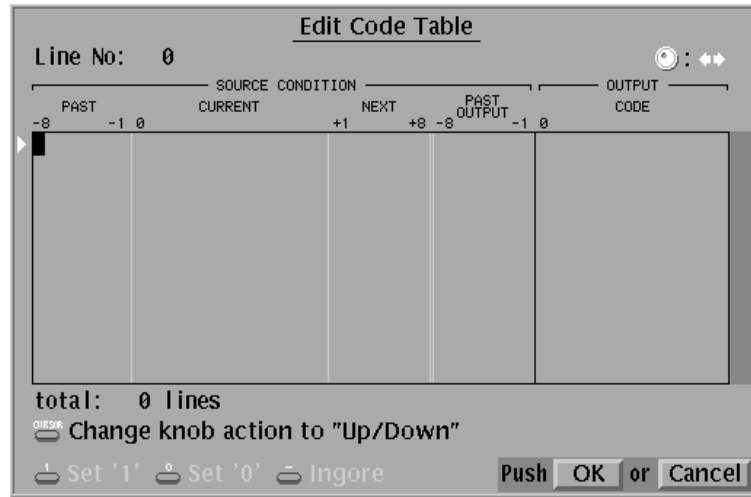

Figure 3-46: Edit code table menu

Table 3-15 describes the parameter items in the **Edit Code Table** menu.

Refer to *Conversion Table Examples* on page C-6 for examples of how to convert pattern data to different format.

Table 3-15: Edit code table parameters

Parameter	Function
PAST	For the template to match, the data in the source immediately behind the current position (i.e. data that has already been read) must match this pattern.
CURRENT	For the template to match, the data in the source at the current position must match this pattern.
NEXT	For the template to match, the data in the source at a position ahead of the current position by the width of the pattern in the CURRENT column must match this pattern.
PAST OUTPUT	For the template to match, the data at the end of the destination (i.e. most recently written data) must match this pattern.
OUTPUT CODE	When the whole template matches, the data specified in this column is written to the destination.

Sub Menu

Item	Function
Insert Empty Line	Inserts an empty line before the line currently indicated by the block cursor.
Delete Line	Deletes the line currently indicated by the block cursor.
Delete All Lines	Deletes all lines in the table.

NOTE. *The maximum size of the table data is 1024 lines.*

Operation. The procedure for editing a code conversion table is as follows: The four arrow buttons are used to move the cursor. The general purpose knob can also be used for cursor movement. The **CURSOR** button causes the general purpose knob to switch between controlling vertical and horizontal movement. Use these procedures to move the cursor to the target location and then use the numeric keys to edit the data. Table 3-16 lists the roles of the numeric keys.

Table 3-16: Numeric key description

Numeric key	Description
0	Sets the table data at the cursor to 0.
1	Sets the table data at the cursor to 1.
-	Sets the table data at the cursor to the don't-care state.

The delete key clears the table data in the area that contains the cursor.

Sometimes, data at positions other than the cursor position may be changed. For example, pressing 0 or 1 near the center of the **SOURCE CONDITION**'s **CURRENT** field when the field is empty changes data from the start of that area to the cursor position.

Make Sequence Menu

A sequence is a list of data pattern blocks and/or subsequence tasks. The DG2020A executes sequences in the order listed. In the sequence table, repeat count, trigger wait, event jump and calling subsequences are used, as well as placing the blocked patterns in a order.

- A patterned data or subsequence can be defined in each line in the sequence table.
- A line can be repeated on output from 1 to 65536 times or infinitely.
- A line can wait trigger event for output.
- A line can be jumped to a specified line by the trigger of event signal.

Figure 3-47 shows an example of a sequence. In this example, two subsequences SUB1 waiting trigger event, a blocked pattern data BK1 to be infinitely repeated and jumped to the line 3 on event signal, and blocked pattern data BK4 are defined.

Line number of the current line pointer position → 2

Line pointer →

LINE NUMBER	No.	BLOCK NAME	REPEAT COUNT	INF	ENHANCED TRIG ON EVENT WAIT	JUMP TO		
0	1	SUB1	1		ON	---	81920.000000	ns
1	1	SUB1	1		ON	---	81920.000000	ns
2	1	BK1		∞	---	3	∞	
3	4	BK4	1		---	---	2560.000000	ns
total		4 lines						

Figure 3-47: Make sequence menu and a sequence example

NOTE. Enhanced columns in Figure 3-47 does not become effective unless the run mode is not set to Enhanced. For enhanced mode, refer to Run Mode Menu on page 3-73.

As already stated, sequence can call subsequences. Each subsequence is composed of blocked patterns with specified repeat count.

Figure 3-48 shows an example of a subsequence. This subsequence is called by the sequence shown in Figure 3-48.

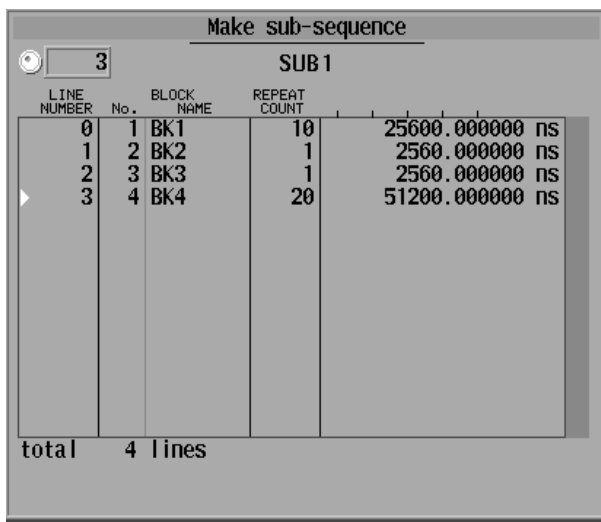

Figure 3-48: Make sub-sequence menu and a subsequence example

NOTE. More than 2,048 lines can be input in the Sequence table. However, only first 2,048 steps expanded in the sequence memory are effective and no error message may not be displayed when executed. For detail about the number of steps, refer to Sequence Memory Usage on page 3-58.

Insert Inserts a new sequence step at the position of the line pointer.

Operation. Insert a sequence step

Bottom button	Popup menu	Side button
Make Sequence		
Move the cursor to the line where the step is to be inserted using the general purpose knob.		
		Insert
	Select the block.	OK

Delete Deletes the sequence step at the position of the line pointer.

Operation. Delete a sequence step

Bottom button	Popup menu	Side button
Make Sequence		
Move the cursor to the line where the step is to be deleted using the general purpose knob.		
		Delete

Repeat Count Sets the block repeat count for the step at the position of the line pointer.

Operation. Set the block repeat count for the step

Bottom button	Popup menu	Side button
Make Sequence		
Move the cursor to the line where the repeat count is to be set using the general purpose knob.		
		Repeat Count (set the repeat count)

Set Enhanced Control Sets up the sequence control options that become valid when the instrument is in enhanced mode. See the **Enhanced** item in the **Run Mode** menu of the **SETUP** for the enhanced operation.

Sub Menu

Item	Function
Trig Wait	When set to ON, data output stops when the specified sequence position is reached and the instrument waits for a trigger input.
Event Jump	When set to ON, if an event occurs during output of the specified line, control jumps to the set line.
Jump to	Specifies the jump destination (line number) for the Event Jump function.
Repeat	When Count is selected, that block is repeated the number of times specified by the Repeat Count setting. When Infinite is selected, the block is repeated indefinitely.

Special Deletes and registers sequences.

Sub Menu

Item	Function
Delete All	Deletes all sequences.
Make Simple Sequence	Registers all currently-defined blocks in order as a sequence.
Edit Sub-Sequence	Creates or edits subsequence. You create and edit subsequences using the same procedures as for sequences. Subsequences can only contain blocks and repeat count commands. Refer to <i>Creating and Editing Subsequence</i> described in the next paragraph.

Creating and Editing Subsequence

You can newly create a subsequence or edit existed a subsequence. Use the menu items under the **Edit Sub-Sequence** menu item.

Item	Function
New	Creates a new subsequence. When you select New, the DG2020A displays the Make sub-sequence popup menu and side menu items. Use these menu items to create and edit a new subsequence.
Open	Opens a subsequence to be edited. When the Open is selected, the popup menu for subsequence selection list brings up. Select a subsequence from the list, then the Make Sub-Sequence popup menu and the side menu including Insert, Delete, Repeat and OK appear. Use these menu items to edit the subsequence.
Remove	Removes a subsequence. When the Remove is selected, the popup menu for subsequence selection list brings up. Select a subsequence to be removed.
Clear	Removes all existing subsequences.

Limitations on Using Subsequences

The following list describes limitations on using subsequences:

- Each line can contain only one data pattern block
- Each line can be repeated up to 65,536 times
- Each subsequence can contain up to 256 lines
- You can define up to 50 subsequences

Sequence memory usage. Sequence memory controls the maximum number of subsequence calls and their repeat counts that can be run. When you run a sequence, the DG2020A compiles the sequence and subsequence lines into internal codes that are stored in the sequence memory. The DG2020A then uses the sequence memory code to output the block data. There is one internal code item for each sequence line except for lines that contains a subsequence call.

For subsequence calls without a repeat count, the DG2020A compiles a number of internal code items equal to the number of lines in the subsequence.

For subsequence calls with a repeat count, the DG2020A compiles a number of internal code items equal to the repeat count for that subsequence call times the number of lines in the subsequence. For example, if a sequence line has a subsequence call with the repeat count of 25 and that subsequence has two lines, the DG2020A generates 50 internal code items for that sequence line and stores them in the sequence memory. This occurs for each subsequence call. The figure below illustrates how the DG2020A compiles the sequence and subsequences into the internal codes and stores them in the sequence memory.

Sequence and subsequence example
 Suppose that the block pattern data: BK1, BK2, BK3, BK5 and BK7 has been created in the pattern memory.

Sequence:

BK1	6	
SUB8	25	Subsequence call
BK2	1	
SUB8	15	
BK3	4	
SUB8	5	

Subsequence: SUB8

BK7	2
BK5	3

Compile

Internal code image in the sequence memory

BK1	Repeat 3	}	25 times
BK7	Repeat 2		
BK5	Repeat 3		
...			
BK7	Repeat 2	}	15 times
BK5	Repeat 3		
BK2	Repeat 1		
BK7	Repeat 2	}	5 times
BK5	Repeat 3		
BK3	Repeat 4		
...			
BK7	Repeat 2		
BK5	Repeat 3		

Defining subsequence calls with large repeat counts can generate internal code that consumes a large amount of sequence memory. This can result in insufficient memory errors. The DG2020A does not check for sequence memory availability errors. If you run a sequence and the DG2020A displays a memory error message, reduce the number of subsequence calls, number of repeat counts and/or number of lines in the subsequences.

NOTE. *The maximum step size of the sequence, including sequence and subsequences, is 2048.*

Event Jump Function

In enhanced mode the sequence program can jump to the line number set in the **Event Jump** field in response to an event input from the pod when the output reaches the end of the block in the block field. This is called the event jump function.

The event jump function can be applied to any line in the sequence program with the **Make Sequence** menu **Set Enhanced Control** → **Event Jump** menu item.

In enhanced mode, after the block data for a sequence program for which the event jump function has been set has finished outputting, the DG2020A determines whether to perform an event jump.

The fact that an event request occurred is stored in a flip-flop in the pattern control circuit when either a low level to high level transition occurs in the pod event input, or the front panel **STEP/EVENT** button is pressed.

Then, when the end of the output of the block in a line for which the **Event Jump** item is set approaches, the DG2020A checks the state of that flip-flop, activates the event jump operation, and clears the flip-flop. Keep it in mind that, even in the trigger wait state and during the output of data for a block for which the **Event Jump** item was set to off, a rising edge in the signal applied to the event input is seen as an event request, and causes the next event jump operation to occur.

The event jump operation occurs even if the block pattern has not been output for the number of repeats set in the sequence program. When an event jump operation occurs, a positive TTL-level pulse 8 clocks wide is output from the front panel event output connector 22 clocks before the block pattern switches.

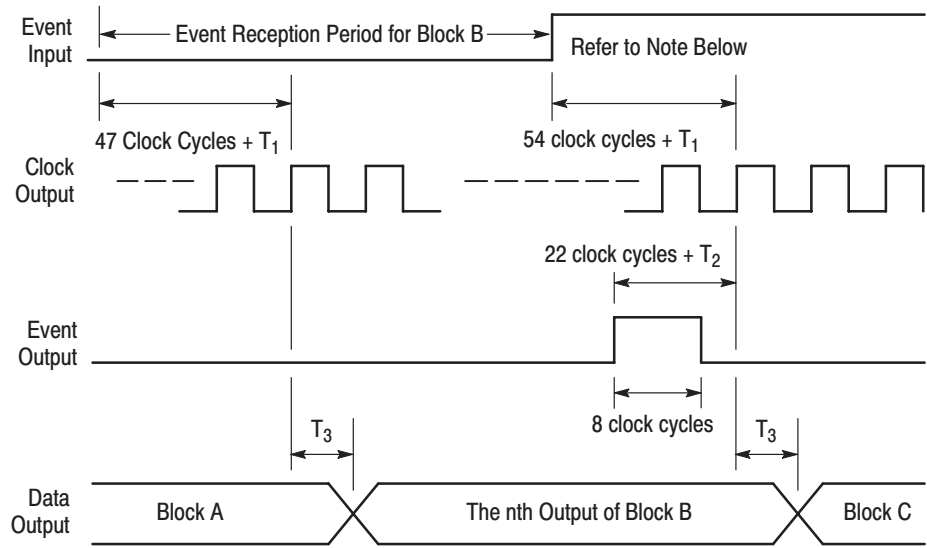

- n: A value between 1 and the value determined by the iteration count
- T_1 : A delay time mainly determined by the pod
- T_2 : The event output delay time
- T_3 : The delay time between clock output and data output

Figure 3-49: Event jump operation timing

Undo

Reverses editing operations performed on the data. Immediately after the Undo function is used, executing **Undo** again executes the reversed editing operation.

SETUP Menu

The bottom menu for the **SETUP** menu includes the **Group Assign, Pod Assign, Level/Delay, Pod Control, Run Mode, Trigger,** and **Oscillator** items. This section describes these items. Table 3-17 lists the functions of the **SETUP** menu items and the pages where their documentation appears.

Table 3-17: Setup menu functions

Bottom menu	Side menu or popup menu	Function	Page
Group Assign	Add Group	Adding a group	3-65
	Delete Group	Deleting a group	3-66
	Rename	Renaming a group	3-67
	Group Bit(s) Config	Changing a group's bit configuration	3-67
	Reset All bits Assign	Deleting a group definition	3-67
Pod Assign	Assign	Pod data assignment	3-68
	Release	Clearing a data assignment	3-69
	Change Inhibit Control	Setting the high-impedance control method	3-69
Level/Delay	High Level (Only valid for the P3420.)	Setting the pod output high level	3-70
	Low Level (Only valid for the P3420.)	Setting the pod output low level	3-70
	Delay	Setting the pod output delay	3-71
	Z on Stop	Setting the output impedance when output is stopped	3-71
Pod Control	Event Level	Setting the event control input level	3-71
	Inhibits Level	Setting the inhibit control input level	3-72
	POD A Event	Controlling the event input signal for POD A	3-72
Run Mode	Repeat	Setting the run mode	3-73
	Single		3-73
	Step		3-74
	Enhanced		3-74
	Update	Setting the data update method	3-75
Trigger	Slope	Setting the trigger slope	3-76
	Level	Setting the trigger level	3-76
	Impedance	Setting the trigger input impedance	3-77

Table 3-17: Setup menu functions (Cont.)

Bottom menu	Side menu or popup menu	Function	Page
Oscillator	Source	Setting the clock source	3-77
	Int Frequency	Setting the internal clock frequency	3-77
	Ext Frequency	Inputting an external clock frequency	3-78
	PLL	Setting up the PLL circuit	3-78

CRT Display

This section describes the **SETUP** menu screen. Figure 3-50 shows the menu. Table 3-18 provides descriptions and page number references.

Screen displayed when a P3410
TTL level output pod is used.

Screen displayed when a P3420
variable output level pod is used.

Figure 3-50: SETUP menu

Table 3-18: Setup menu CRT display

Screen Reference	Function	Page
1	Shows the signal generation mode (run mode).	3-73
2	Shows the trigger input settings (slope, impedance, and level).	3-76
3	Shows the reference clock settings and the PLL circuit on/off state.	3-76
4	Shows the method selected for data output high-impedance control.	3-69
5	Shows the pod output delays. Delays can only be set for pod channels 08 to 11 for each pod.	3-71
6	Shows the high and low values of the output voltage. These voltages can be set to arbitrary values between -3 and 7 V for the P3420 pod.	3-70
7	Shows the data bits and the group to which each data bit belongs.	
8	Shows the pod channel. The pods are labeled A through C, and the channels are numbered 00 through 11.	

Group Assign Menu

This menu is used to define groups for data bits. Up to 36 groups can be defined. The popup menu shown in Figure 3-51 displays a table of the currently defined groups.

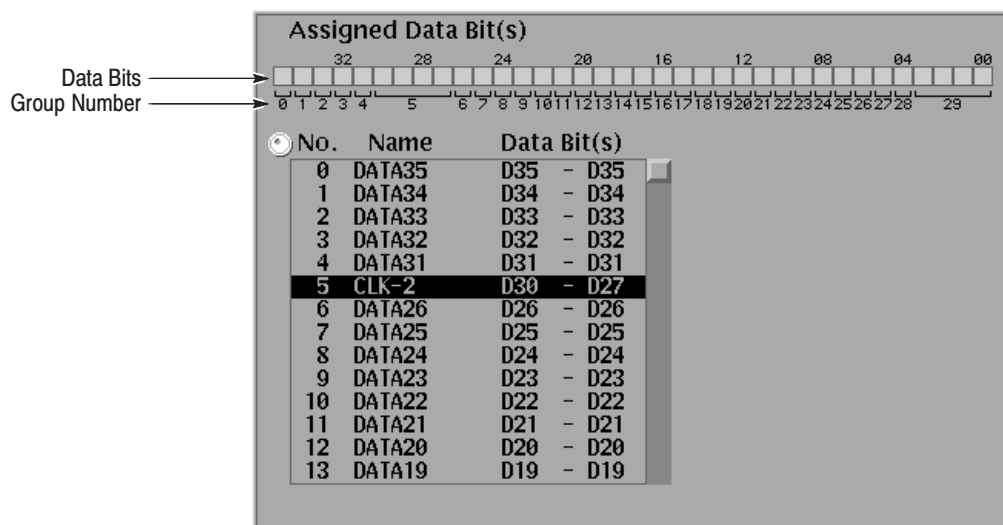

Figure 3-51: Group assign popup menu

Add Group

Adds a new group. A new group cannot be added if there are already 36 groups defined.

The bit structure of a group is defined by specifying the MSB and LSB of the group. If the bit structure of a new group overlaps with that of an existing group, the newly defined group takes precedence and the structure of the existing group is automatically modified. Figure 3-52 shows an example of a bit structure assignment.

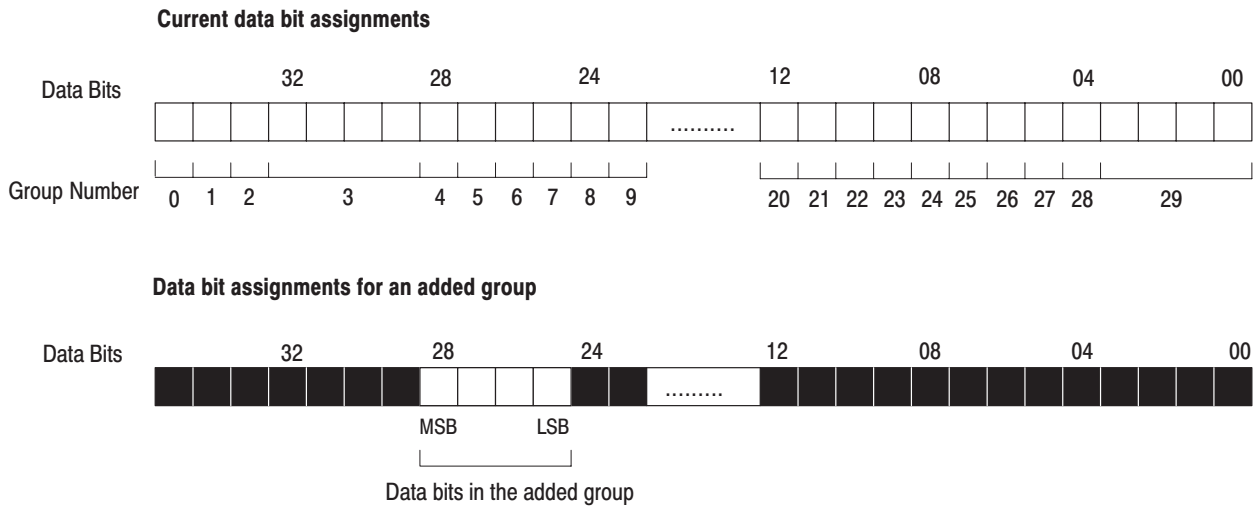

Figure 3-52: Bit structure assignment

Operation: Add a group

Bottom button	Popup menu	Side button
Group Assign		Add Group
	Input the name of the new group.	OK
		MSB (Specify the MSB.)
		LSB (Specify the LSB.)
		OK
		OK

Delete Group

Deletes the group selected with the cursor. This function asks for confirmation before actually deleting the group.

Operation: Delete a group

Bottom button	Popup menu	Side button
Group Assign	Select the group to be deleted.	Delete Group
		OK

Rename Changes the name of the group selected with the cursor.

Operation: Rename a group

Bottom button	Popup menu	Side button
Group Assign	Select the group whose name is to be changed.	Rename
	Input a new name.	OK

Group bit(s) Config Changes the bit configuration of the group selected with the cursor. If the result of the changed configuration overlaps an existing group, the newly defined group takes precedence.

Operation: Change a group's bit configuration

Bottom button	Popup menu	Side button
Group Assign		Group Bit(s) Config
		MSB (Specify the MSB)
		LSB (Specify the LSB)
		OK

Reset All bits Assign Deletes the currently defined group definitions and returns the group settings to the initial state. (See Appendix C.)

Operation: Delete a group definition

Bottom button	Popup menu	Side button
Group Assign		Reset All bits Assign
		OK

Pod Assign Menu

This menu is used to define which data bits are assigned to which channel. The menu lists the data bits at the right and the pod channels at the left. (See Figure 3-53.) Use the general purpose knob to select data bits and the up and down arrow buttons to select pod channels.

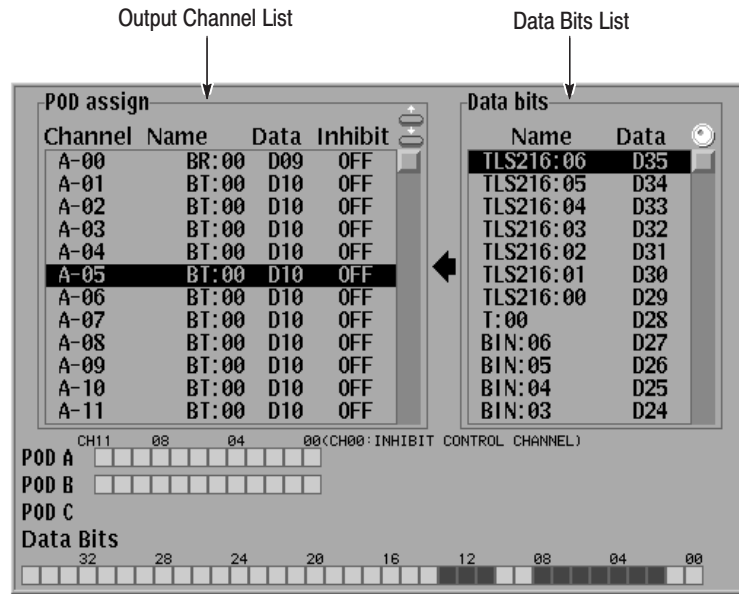

Figure 3-53: Pod assign popup menu

NOTE. Note that the settings performed using the *Pod Assign* menu do not take effect unless the **OK** button is pressed.

Assign Assigns the selected data bit to the selected pod channel. The currently set value is overwritten.

Operation: Assign pod data

Bottom button	Popup menu	Side button
Pod Assign		
Select a data bit with the general purpose knob.		
Select the channel to be assigned using the up and down arrow buttons.		
		Assign

Release Clears the data for the selected assignment.

Operation: Clear a data assignment

Bottom button	Popup menu	Side button
Pod Assign		
Select the channel for which the data assignment is to be cleared using the up and down arrow buttons.		
		Release

Change Inhibit Control

Sets the control method used to set output channels to the high-impedance state. Table 3-19 shows the four high-impedance state control methods that can be selected for each channel.

Table 3-19: Impedance state control methods

Selection Item	Description
OFF	No high-impedance control (output is always enabled)
Internal	Controlled by the channel 00 signal (high-impedance when high)
External	Controlled by an external impedance control signal (high-impedance when high)
Both	Controlled by both the channel 00 and external impedance control signals (high-impedance when either signal is high)

Since the channel 00 signal for each pod cannot control its own high-impedance state, these channels must be set to either **OFF** or **External**. Figure 3-54 shows a schematic overview of the high-impedance control circuit.

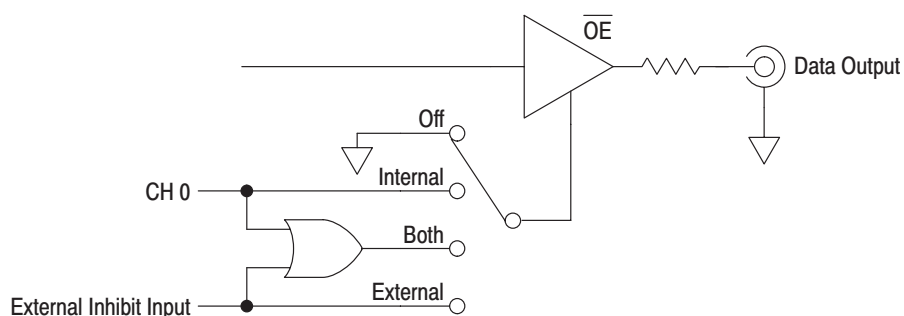

Figure 3-54: High-impedance control circuit

Operation: Set the high-impedance control method

Bottom button	Popup menu	Side button
Pod Assign		
Select the channel to be set up for high-impedance control with the up and down arrow buttons.		
		Channel Inhibit Control
	Select one of Off, Internal, External, or Both.	
		OK

Level/Delay Menu

This menu sets the pod output voltage and delay, and whether or not output is disabled in the output stopped state.

NOTE. *Certain of these parameters cannot be changed for the P3410 (TTL level output) pod. When that pod is being used the corresponding side menu items will be dimmed so that the settings cannot be changed.*

High Level (P3420 only)

Determines the output voltage when the data value is 1. The difference between the high level and low level voltages must be between 0.5 and 9 V. The displayed voltages are the voltages when the outputs are open.

Operation: Set the pod output high level

Bottom button	Popup menu	Side button
Level/Delay		High Level (the high level setting)

Low Level (P3420 only)

Determines the output voltage when the data value is 0. The difference between the low level and high level voltages must be between 0.5 and 9 V. The displayed voltages are the voltages when the outputs are open.

Operation: Set the pod output low level

Bottom button	Popup menu	Side button
Level/Delay		Low Level (the low level setting)

Delay The delay in channels 08 to 11 in each pod can be adjusted. The delay can be set in the range 0.0 to 20.0 ns in 0.1 ns steps.

Operation: Set the pod output delay

Bottom button	Popup menu	Side button
Level/Delay		Delay (the delay setting)

Z on Stop Sets whether all outputs should be set to the high-impedance state or whether they should continue to output their current values when the output is stopped with the **START/STOP** button. When **Z on Stop** is set to **On**, the pod output is set to the high-impedance state.

Operation: Set the output impedance when output is stopped

Bottom button	Popup menu	Side button
Level/Delay		Z on Stop (select On or Off)

Pod Control Menu

This menu sets the pod input control threshold level for the P3420. This level is fixed at 1.4 V in the P3410 pod (the TTL pod). When multiple P3420 pods (variable output level pods) are used, all of those pods are set to the same threshold level.

Event Level Sets the event control input threshold level. This level can be set in the range -5 to $+5$ V.

Operation: Set the event level

Bottom button	Popup menu	Side button
Pod Control		Event Level (Set the event level.)

Inhibit Level Sets the inhibit control input threshold level. This level can be set in the range -5 V to +5 V.

Operation: Set the inhibit level

Bottom button	Popup menu	Side button
Pod Control		Inhibit Level (Set the inhibit level.)

Pod A Event Switches the enable/disable of the event input signal for POD A. Option 01 instruments also have the **POD B Event** menu item, and Option 02 instruments have the **POD C Event** menu item as well.

Operation: Control the event input signal for POD A

Bottom button	Popup menu	Side button
Pod Control		POD A Event (Select Enable or Disable)

Run Mode Menu

This menu sets the run mode used to output pattern data, and sets the pattern data output update method used when data is changed.

Operation: Set the run mode

Bottom button	Popup menu	Side button
Run Mode		Select the run mode (Repeat, Single, Step, or Enhanced)

Repeat

Pattern data is iteratively output. When no sequence is defined, all of the pattern data is output iteratively as a single pattern as shown in Figure 3-55. If a sequence is defined, the sequence ordering and repeat (**Repeat Count**) functions are applied. The extended sequence functions (trigger input, event jump, etc.) are ignored as shown in Figure 3-56.

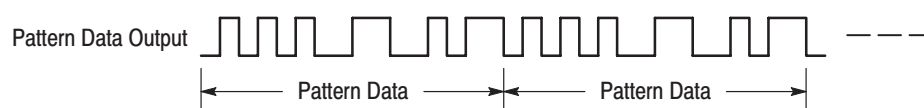

Figure 3-55: Repeat mode pattern data output (when no sequence is defined)

Line No.	Block	Repeat Count
0	BK0	1
1	BK1	3
2	BK2	2

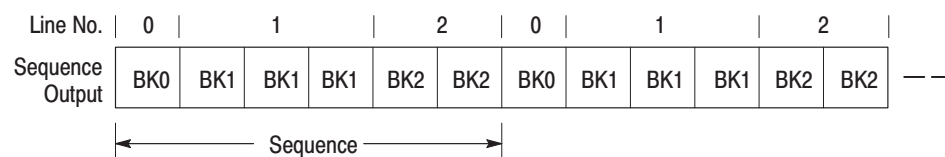
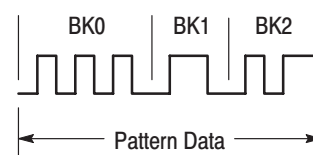

Figure 3-56: Repeat mode pattern data output (when a sequence is defined)

Single

Pattern data is output only once. Pattern data is output when a trigger input is received. A trigger signal is received either when the front panel **FORCE TRIGGER** button is pressed or when an external trigger signal is input to the **TRIGGER INPUT** connector.

When no sequence is defined, all of the pattern data is output as a single waveform as shown in Figure 3-57. If a sequence is defined, the sequence ordering and repeat (**Repeat Count**) functions are applied as shown in Figure 3-58. The extended sequence functions (trigger input, event jump, etc.) are ignored.

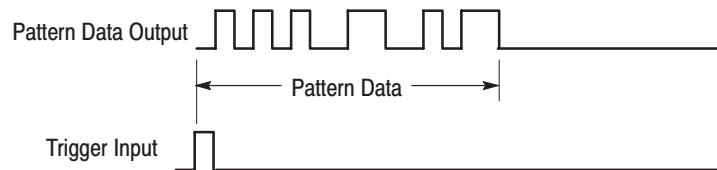

Figure 3-57: Single mode pattern data output (when no sequence is defined)

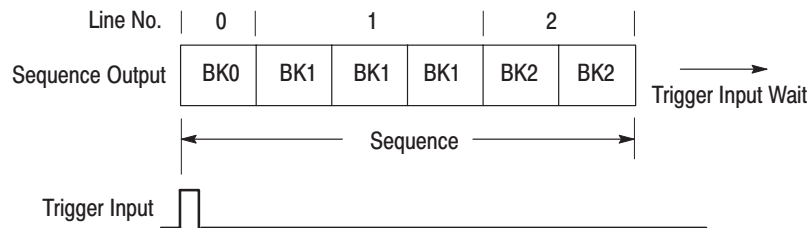
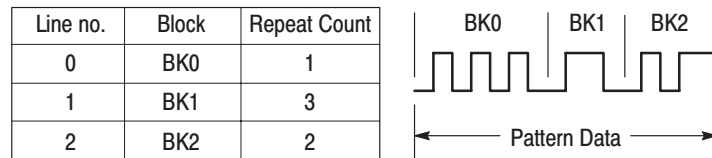

Figure 3-58: Single mode pattern data output (when a sequence is defined)

Step Pattern data is output not according to the internal clock, but rather according to a clock signal generated manually with the **STEP/EVENT** button. Pattern data is output using the method used by the **Repeat** item.

Enhanced Pattern data is output as defined by the sequence. The extended sequence functions (trigger input, event jump, etc.) are valid during this output. The **Repeat Count** item setting is used for sequences for which the repeat count is not set to **Infinite**. Figure 3-59 shows an example of an enhanced mode sequence. Also refer to the description of the **EDIT** menu **Make Sequence** menu on page 3-54.

Line No.	Block	Repeat Count	Trigger Input (Trig Wait)	Event Jump
0	BK0	1	On	
1	BK1	Infinite		2
2	BK2	2		
3	BK3	2	On	
4	BK4	5		0

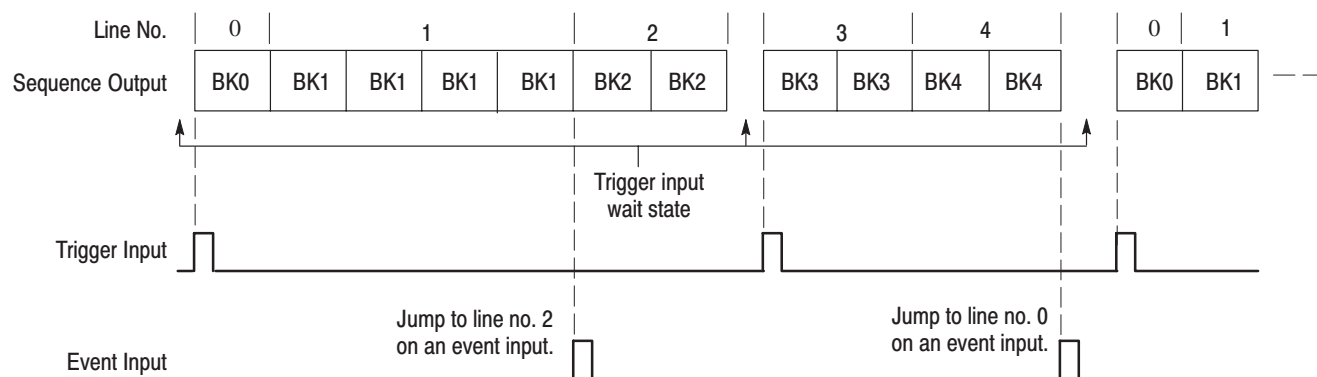

Figure 3-59: Enhanced mode sequence output

Update Sets the update method for rewriting data to the output when pattern data, the sequence, or other items are changed. Select **Auto** or **Manual**.

Auto. Rewrites the output data with new data immediately at the point when any change occurs to the pattern data. The **START/STOP** button LED indicator blinks rapidly during data update.

Manual. The output data is not immediately rewritten when the pattern data is changed. When the displayed data and the output data differ, the **START/STOP** button's LED indicator blinks slowly. To rewrite the pattern data, stop data output temporarily by pressing the **START/STOP** button, and then restart output by pressing the **START/STOP** button once again. Also note that changed pattern data is also written when the run mode changes.

Operation: Set the data update method

Bottom button	Popup menu	Side button
Run Mode		Update (Select Auto or Manual.)

Trigger Menu

This menu sets the trigger settings. Figure 3-60 shows the setting selections.

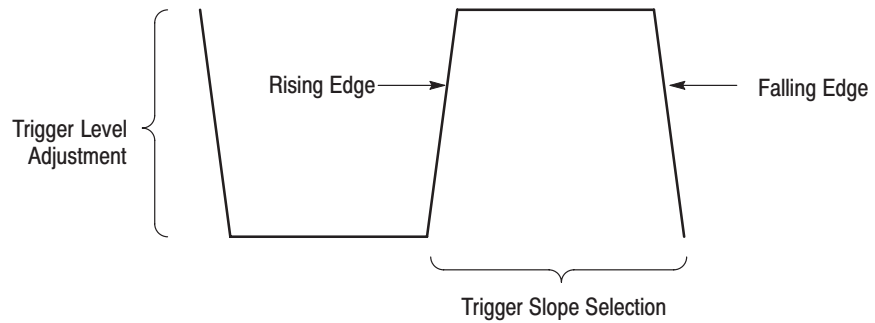

Figure 3-60: Trigger slope and level control

Slope Sets whether a trigger is recognized on either a rising or falling edge of the signal applied to the trigger input.

Positive: Rising edge

Negative: Falling edge

Operation: Set the trigger slope

Bottom button	Popup menu	Side button
Trigger		Slope (Select Positive or Negative.)

Level Sets the threshold voltage for detecting a trigger. The value can be set from -5 to $+5$ V in 0.1 V steps.

Operation: Set the trigger level

Bottom button	Popup menu	Side button
Trigger		Level (Set the trigger level.)

Impedance

Sets the trigger input connection input impedance. An impedance of either **50Ω** or **1KΩ** can be set.

Operation: Set the trigger input impedance

Bottom button	Popup menu	Side button
Trigger		Impedance (Select 50Ω or 1KΩ.)

Oscillator Menu

Determines the reference clock (and clock rate) used when pattern data is output.

Source

Determines whether the internal oscillator (**Int**) or an external input clock (**Ext**) is used as the reference clock.

Operation: Set the clock source

Bottom button	Popup menu	Side button
Oscillator		Source (Select Int or Ext.)

Int Frequency

Sets the internal clock oscillator frequency. The frequency can be set in the range 100 MHz to 200 MHz. When **Source** is set to **Int**, the time axis resolution used for the display of pattern data will be the reciprocal of this setting.

Operation: Set the internal clock frequency

Bottom button	Popup menu	Side button
Oscillator		Int Frequency (Set the frequency.)

Ext Frequency Input a clock oscillator frequency in addition to the external clock input. The frequency can be set in the range 100 mHz to 200 MHz. When **Source** is set to **Ext**, the time axis resolution used for the display of pattern data will be the reciprocal of this setting.

Operation: Input an external clock frequency

Bottom button	Popup menu	Side button
Oscillator		Ext Frequency (Set the frequency.)

PLL Sets whether or not the PLL (phase locked loop) circuit is used for internal oscillator frequency control. When this setting is **On** (PLL circuit used), the instrument can provide a clock with a high frequency precision. When **Off**, the instrument can provide a clock synchronized to an external trigger input. The off state eliminates jitter due to differences in the relative timing of the clock and the trigger signal.

Operation: Set up the PLL circuit

Bottom button	Popup menu	Side button
Oscillator		PLL (Select On or Off.)

APPLICATION Menu

APPLICATION Menu

The **APPLICATION** menu is provided to group data pattern generation and editing functions that meet the special requirements of a variety of application areas. There are many practical applications which require the user to perform complex operations if only general purpose functions are provided. However, these operations can often be standardized for a given application area. This menu allows such processing to be performed simply by calling standardized processing procedures that have been provided in advance.

Although there are no items in this menu in the current version of the firmware, Tektronix is planning to provide functions that support several application areas in future versions of the DG2020A firmware. Tektronix will announce the details of the DG2020A version upgrade service when the new firmware is available.

UTILITY Menu

The bottom menus for the **UTILITY** menu includes the **Mass Memory**, **Display/Hardcopy**, **System**, **Status**, and **Diag** items. When one of the bottom menu items is selected the related base menu is displayed. Parameters are selected using these base menus. Table 3-20 lists the functions of the **UTILITY** menu items and the pages where their descriptions appear.

Table 3-20: Menu functions

Bottom menu	Base menu or side menu		Function	Page
Mass Memory	Change Directory		Changing the current directory	3-83
	Make Directory		Creating directories	3-83
	Rename		Changing a file or directory name	3-84
	Copy or Delete	Copy	Copying files	3-84
		Delete	Deleting files	3-84
		Delete All	Deleting all files	3-84
	Special	Initialize Media	Formatting a floppy disk	3-85
		Catalog Order	Setting the directory listing order	3-85
		Lock	Locking a file	3-85
Display/Hardcopy	Display	Clock	Displaying the date and time	3-87
		Brightness	Adjusting the screen brightness	3-87
		Dimmer	Setting the dimmer	3-87
	Hardcopy	Format	Setting the hard copy format	3-88
		Port	Output port setup	3-88
	Clear Message Area		Removing message displays	3-89
System	Remote Port		Remote port setup	3-89
	GPIB	Configure	Setting the GPIB operating mode	3-90
		Address	Setting the GPIB address	3-90
	Serial	Baudrate	Setting the serial interface parameters	3-91
		Data Bits		3-91
		Parity		3-91
		Stop Bits		3-91
		Handshake		3-91

Table 3-20: Menu functions (Cont.)

Bottom menu	Base menu or side menu	Function	Page
System	Power up Pause	Setting the power-on pause	3-91
	Date/Time	Setting the date and time	3-92
	Reset to Factory	Restoring the factory settings	3-92
	Security Immediate	Deleting memory data	3-92
Status		Displaying the status menu	3-93
Diag		Diagnostics	3-93

Mass Memory Menu

This menu is used to manipulate the floppy disk inserted in the instrument's floppy disk drive. This menu supports changing and creating directories, file copying and deleting, and floppy disk formatting.

Change Directory Changes the current directory.

Operation: Change directory

Bottom button	Popup menu	Side button
Mass Memory		Change Directory
	Select the directory to switch to.	OK

Make Directory Creates a sub-directory in the current directory.

Operation: Create a directory

Bottom button	Popup menu	Side button
Mass Memory		Make Directory
	Enter the name of the directory.	OK

Rename Changes the name of a file or directory on the floppy disk. The file extension is not changed by this function.

Operation: Change a file or directory name

Bottom button	Popup menu	Side button
Mass Memory	Select the file or directory to be renamed.	Rename
		Clear String
	Enter the new file or directory name.	OK

Copy or Delete Copies or deletes files on the floppy disk.

Sub Menu

Item	Function
Copy	Copies the selected file on the floppy disk, creating a new file.
Delete	Deletes the selected file from the floppy disk.
Delete All	Deletes all the files in the current directory. <i>Note: If there is a sub-directory in the current directory, and that sub-directory is not empty, it will not be deleted. Also, locked files will not be deleted.</i>

Operation: Copy a file

Bottom button	Popup menu	Side button
Mass Memory		Copy or Delete
	Select the file to copy.	Copy
		OK
	Enter the name of the copy of the file.	OK

Operation: Delete a file

NOTE. When deleting a file, the instrument asks for confirmation. Select either **OK** or **Cancel**.

Bottom button	Popup menu	Side button
Mass Memory		Copy or Delete
	Select the file to delete.	Delete
		OK

Special Supports formatting floppy disks, setting the file listing display order, and setting file locks.

Sub Menu

Item	Function										
Initialize Media	<p>Formats a floppy disk. Selecting this menu item pops up a list of floppy disk formats. Choose the format from the following list to format the floppy disk:</p> <p>IBM-PC 2HD PC9800 2HD J3100 2HD IBM-PC 2DD PC9800 2DD</p> <p>The volume label DG2020A is automatically assigned to the floppy disk by the formatting operation.</p>										
Catalog Order	<p>Specifies the order for display when listing a directory. Select the order from the following types:</p> <table border="1"> <thead> <tr> <th>Type</th> <th>Order</th> </tr> </thead> <tbody> <tr> <td>NAME1</td> <td>ASCII order</td> </tr> <tr> <td>NAME2</td> <td>Reverse ASCII order</td> </tr> <tr> <td>TIME1</td> <td>In order created starting with oldest.</td> </tr> <tr> <td>TIME2</td> <td>In order created starting with newest.</td> </tr> </tbody> </table>	Type	Order	NAME1	ASCII order	NAME2	Reverse ASCII order	TIME1	In order created starting with oldest.	TIME2	In order created starting with newest.
Type	Order										
NAME1	ASCII order										
NAME2	Reverse ASCII order										
TIME1	In order created starting with oldest.										
TIME2	In order created starting with newest.										
Lock	Changes the write protect attribute of the selected file. When the lock attribute is On, writing is prohibited, and when the lock attribute is Off, writing is allowed.										

Operation: Format a floppy disk

NOTE. All data on a disk is deleted by the formatting operation. Always check the contents of a disk before formatting it.

Bottom button	Popup menu	Side button
Mass Memory		Special
		Initialize Media
	Select the format type.	OK
		OK

Operation: Set the directory listing order

Bottom button	Popup menu	Side button
Mass Memory		Special
		Catalog Order (Select the display type.)

Operation: Lock a file

Bottom button	Popup menu	Side button
Mass Memory		Special
		Lock (Select On.)

Display/Hardcopy Menu

This menu is used to set the display and hardcopy settings. Select the items to be changed using the up and down arrow buttons, and change the value or the item using the left and right arrow buttons or the general purpose knob.



Figure 3-61: Display/hardcopy menu

Display Sets the date and time display, adjusts the screen brightness, and sets the dimmer. (The dimmer function automatically reduces the screen brightness if the DG2020A is left for 10 minutes without any controls being used.)

Base Menu

Item	Function
Clock	The date and time are displayed at the upper right of the screen when this setting is On.
Brightness	Adjusts the screen brightness. The value can be set in the range 0 to 100, with 100 being the maximum brightness. The default value is 70.
Dimmer	When set to On, the screen brightness is reduced if about 10 minutes elapses without any front panel control being used. The screen returns to its original brightness when any key is pressed.

Operation: Display the date and time

Bottom button	Popup menu	Side button
Display/Hardcopy	Select Display Clock with the up and down arrow buttons.	
	Select On with the left and right arrow buttons.	

Operation: Adjust the screen brightness

Bottom button	Popup menu	Side button
Display/Hardcopy	Select Display Brightness with the up and down arrow buttons.	
	Adjust the brightness.	

Operation: Set the dimmer

Bottom button	Popup menu	Side button
Display/Hardcopy	Select Display Dimmer with the up and down arrow buttons.	
	Select On with the left and right arrow buttons.	

Hardcopy Sets the screen hard-copy data format settings, and sets the hard-copy output port.

Base Menu

Item	Function		
Format	Sets the screen hard-copy data format. The following are the menu options and the formats they specify.		
	Selection item	Format	
	BMP	Windows BMP	
	Epson	Epson ESC-P	
	EPS mono	Encapsulated Postscript	
	Thinkjet	HP Thinkjet	
	TIFF	TIFF	
Port	Sets the device for screen hard-copy data output.		
	Selection item	Device	
	DISK	Floppy disk	
	GPIB	GPIB	
	RS232C	Serial port	
	When hard-copy output is to the disk, a file name with the format HC_XXX.YYY is used. Here, XXX is a serial number that is started from 000, and YYY is an extension that depends on the format used. XXX is chosen so as not to overwrite existing data. The table below lists the correspondence between formats and extensions.		
	Menu display	Format	Extension
	BMP	Windows BMP	BMP
	Epson	Epson ESC-P	ESC
	EPS mono	Encapsulated Postscript	EPS
	Thinkjet	HP Thinkjet	TJ
	TIFF	TIFF	TIF

Operation: Set the hard copy format

Bottom button	Popup menu	Side button
Display/Hardcopy	Select Hardcopy Format with the up and down arrow buttons.	
	Select the format with the left and right arrow buttons.	

Operation: Output port setup

Bottom button	Popup menu	Side button
Display/Hardcopy	Select Hardcopy Port with the up and down arrow buttons.	
	Select the port with the left and right arrow buttons.	

Clear Message Area Clears the message displayed in the message area.

Operation: Remove message displays

Bottom button	Popup menu	Side button
Display/Hardcopy		Clear Message Area

System Menu

This menu sets the date and time and the GPIB and serial port settings. Select the items to be changed using the up and down arrow buttons, and change the value or the item using the left and right arrow buttons or the general purpose knob.



Figure 3-62: System menu

Remote Port Set the port used for external remote control of the instrument. Either the **GPIB** or the **RS232C** can be selected.

Operation: Remote port setup

Bottom button	Popup menu	Side button
System	Select Remote Port with the up and down arrow buttons.	
	Select the port with the left and right arrow buttons.	

GPIB Sets the GPIB operating mode and address.

Base Menu

Item	Function	
Configure	Sets the GPIB operating mode.	
	Operating mode	Function
	Talk/Listen	Normal remote control
	Talk Only	Used for hard-copy output.
	Off Bus	The connection between the instrument and the bus is set to the disconnected state.
Address	Sets the instrument's GPIB address. The address can be set to a value between 0 and 30.	

Operation: Set the GPIB operating mode

Bottom button	Popup menu	Side button
System	Select GPIB Configure with the up and down arrow buttons.	
	Select the operating mode with the left and right arrow buttons.	

Operation: Set the GPIB address

Bottom button	Popup menu	Side button
System	Select GPIB Address with the up and down arrow buttons.	
	Select the address with the general purpose knob.	

Serial Sets the baud rate, data length for transmitted data, parity, number of stop bit, and flow control method for the serial port. These parameters are set to match the settings of the connected computer.

Base Menu

Item	Function
Baudrate	Sets the transmission rate for the serial port. A transmission rate of 300, 600, 1200, 2400, 4800, 9600, or 19200 can be set.
Data Bits	Sets the data length for the transmitted data. A data length of 7 or 8 bits can be set.
Parity	Sets the kind of parity bit attached to transmitted data. The parity can be set to None, Even, or Odd.
Stop Bits	Sets the number of stop bits. 1 or 2 stop bits can be set.
Handshake	Sets the flow control method. Either Off, Soft, or Hard can be set for the flow control.

Operation: Set the serial interface parameters

Bottom button	Popup menu	Side button
System	Select the Serial parameter with the up and down arrow buttons.	
	Select the item with the left and right arrow buttons.	

Power up Pause Sets whether or not the instrument should wait for key input before starting operation if a diagnostics error was detected at start up or if no pods are connected to the instrument. This setting is useful in cases where, for example, the system is configured with no output pods connected and you do not want the system waiting for key input.

Operation: Set the power-on pause

Bottom button	Popup menu	Side button
System	Select Power up Pause with the up and down arrow buttons.	
	Select On with the left and right arrow buttons.	

Date/Time Sets the internal clock's date and time.

Operation: Set the date and time

Bottom button	Popup menu	Side button
System	Select Date/Time with the up and down arrow buttons.	
	Select the parameter to change with the left and right arrow buttons.	
	Set the date and time with the general purpose knob.	

Reset to Factory Resets the instrument's settings to the factory settings state. The instrument's internal memory is not cleared by resetting to the factory settings. See Appendix C for a table listing the instrument's factory settings

Operation: Restore the factory settings

Bottom button	Popup menu	Side button
System		Reset to Factory
		OK

Security Immediate Erases the instrument's internal memory data. At the same time, the instrument is reset to the factory settings state.

Operation: Delete memory data

Bottom button	Popup menu	Side button
System		Security Immediate
		OK

Status Menu

Displays the instrument's model number, the firmware version, the instrument's configuration, and other information. See Figure 3-63.



Model:	DG2020A	FV:1.10
Manufacturer:	TEKTRONIX	
IEEE488:	IEEE Std. 488.2-1987	
	CF:91.1CN	
	SH1, AH1, T5, L4, SR1, RL1, PP0, DC1, DT1, C0, E2	
Configure:	Clock	Installed
	Unit0	Installed
	Unit1	-----
	Unit2	-----

Figure 3-63: Status menu

Diag Menu

Tests the instrument's internal hardware. Diagnostics can be run as individual tests, or all tests can be run in one operation. If the diagnostics complete with no errors, "Pass" is displayed in the **Status** display area. If an error occurs, "Fail" is displayed. An error code is displayed in the **Comment** display area if a diagnostic test fails. See Figure 3-64.

NOTE. Contact your Tektronix sales representative if any errors occur.

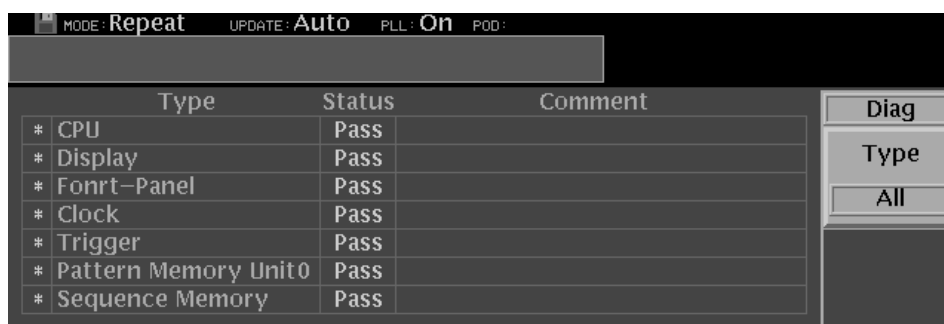

Type	Status	Comment
* CPU	Pass	
* Display	Pass	
* Front-Panel	Pass	
* Clock	Pass	
* Trigger	Pass	
* Pattern Memory Unit0	Pass	
* Sequence Memory	Pass	

MODE: Repeat UPDATE: Auto PLL: On POD:

Diag
Type
All

Figure 3-64: Diag menu

Table 3-21 shows the failure meaning and failure board for the error code. See the DG2020A Service Manual for detailed descriptions of the error codes.

Table 3-21: Error code

Error code	Error meaning	Failed component
1XX	CPU diagnostics error	A6 CPU board
2XX	Display diagnostics error	A6 CPU board
3XX	Front panel diagnostics error	A12 Key board
4XX	Clock diagnostics / calibration error	A30 Clock board
5XX	Trigger diagnostics / calibration error	A30 Clock board
6XX	Sequence memory error	A50 / A51 PG board
7XX	Pattern memory diagnostics error	A50 / A51 PG board

Side Menu

Item	Function
Type	Selects the diagnostics test. Either individual items or all tests (All) can be selected. An asterisk is displayed next to selected items.
Execute	Executes the diagnostic tests for the items marked with an asterisk.

Operation: Diagnostics

Bottom button	Popup menu	Side button
Diag		Type (Select a diagnostic test or "All" with the general purpose knob.)
		Execute

Appendix A: Performance Characteristics

The performance characteristics on the DG2020A can be divided into three categories:

- **Nominal Traits.** General characteristics are described not by equipment performance and limits but by such things as memory capacity.
- **Warranted Characteristics.** Warranted characteristics are described in terms of quantifiable performance limits which are guaranteed.
- **Typical Characteristics.** Typical characteristics are described in terms of typical or average performance for the DG2020A. The characteristics described herein are not absolutely guaranteed.

Items marked with * are tested in the *Performance Verification* (Appendix B).

The certification and compliances for the DG2020A are also found at the end of this appendix.

Warranted Characteristics

This section will describe the warranted characteristics of the DG2020A. These can be divided into two main categories: electrical characteristics and environmental characteristics.

Performance Conditions

The electrical characteristics are valid under the following conditions:

1. The instrument must be in an environment whose limits are described in Environmental Characteristics.
2. All tolerance limits apply after a 20 minute warm up.
3. The instrument is operating at an ambient temperature between +10 °C to +40 °C, unless otherwise noted.

Items marked with * are tested in the Performance Verification (Appendix B)

Table A-1: Warranted electrical characteristics

Characteristics	Description	Performance Test
Clock generator		
*Internal clock		Check internal clock frequency, page B-6.
Frequency accuracy		
PLL on	± 50 ppm ($\pm 0.005\%$)	
PLL off	$\pm 3\%$	
P3410 (TTL output pod)		
Data output		Check output voltage levels, page B-19.
*Output voltage		
V _{OH}	> 4.4 V into 1 M Ω > 3.5 V at 10 mA	
V _{OL}	< 0.1 V into 1 M Ω < 0.8 V at 10 mA	
Rise / fall time	< 5 ns (20% to 80%, into 1 M Ω 10 pF)	
*Delay accuracy	± 2.0 ns (CH0 reference)	Check variable delay, page B-20.

Table A-1: Warranted electrical characteristics (Cont.)

Characteristics	Description	Performance Test
P3420 (Variable output pod)		
Data output		
*Output voltage accuracy	$\pm 3\% \pm 0.1 \text{ V}$ (into 1 M Ω)	Check output voltage levels, page B-25.
*Delay accuracy	$\pm 3\% \pm 0.8 \text{ ns}$ (CH0 reference)	Check variable delay, page B-29.
Rise / fall time	< 4ns (20% to 80%, into 1 M Ω 10 pF, 0 to 5 V Swing)	
Auxiliary outputs		
Sync output		
Delay from external trigger input	(T_{d1} in Figure A-1)	
	Clock Setting	Delay
	Internal Clock, PLL ON, > 6.25 MHz	18 ns to 55 ns
	Internal Clock, PLL ON, \leq 6.25 MHz	30 ns to 70 ns
	Internal Clock, PLL OFF, > 6.25 MHz	20 ns to 50 ns
	Internal Clock, PLL OFF, \leq 6.25 MHz	35 ns to 70 ns
	External Clock	(15 ns + 0.5 clock) to (30 ns + 1.5 clock)
Delay from external clock input	16 ns to 30 ns	
Clock output		
Level	$V_{OH} > 0.8 \text{ V}$ (typ. 1.0 V) $V_{OL} < 0.2 \text{ V}$ (typ. 0.0 V) (into 50 Ω)	
Delay from external trigger input	(T_{d2} in Figure A-1)	
	Clock Setting	Delay
	Internal Clock, PLL ON, > 6.25 MHz	15 ns to 40 ns
	Internal Clock, PLL ON, \leq 6.25 MHz	25 ns to 60 ns
	Internal Clock, PLL OFF, > 6.25 MHz	15 ns to 45 ns
	Internal Clock, PLL OFF, \leq 6.25 MHz	25 ns to 60 ns
	External Clock	(7 ns + 0.5 clock) to (20 ns + 1.5 clock)
Delay from external clock input	8 ns to 15 ns	

Table A-1: Warranted electrical characteristics (Cont.)

Characteristics	Description	Performance Test
Auxiliary inputs		
Trigger input		
Threshold		
Accuracy	$\pm 5\% \pm 0.1 V$	
Pulse width	$> 5 \text{ ns}$ (at 0.2 V amplitude)	
Sensitivity	$> 0.2 V$ (at 1 MHz square wave)	
Maximum input	$\pm 10 V$ (1 k Ω) $\pm 5 V$ (50 Ω)	
Delay to P3410 data output	(T_{d3} in Figure A-1)	
	Clock Setting	Delay
	Internal Clock, $> 6.25 \text{ MHz}$	30 ns to 65 ns
	Internal Clock, $\leq 6.25 \text{ MHz}$	45 ns to 80 ns
	External Clock	(25 ns + 0.5 clock) to (45 ns + 1.5 clock)
Delay to P3420 data output	(T_{d3} in Figure A-1)	
	Clock Setting	Delay
	Internal Clock, $> 6.25 \text{ MHz}$	30 ns to 60 ns
	Internal Clock, $\leq 6.25 \text{ MHz}$	40 ns to 70 ns
	External Clock	(20 ns + 0.5 clock) to (40 ns + 1.5 clock)
Trigger hold off	$< 500 \text{ ns}$	
*External clock input		Check external clock input, page B-8.
Threshold level	$V_{IH} > 0.7 V, V_{IL} < 0.3 V$	
Maximum input voltage	$\pm 2 V$	
Frequency	DC to 200 MHz	
Delay to P3410 data output	25 ns to 45 ns	
Delay to P3420 data output	20 ns to 40 ns	

Table A-1: Warranted electrical characteristics (Cont.)

Characteristics	Description	Performance Test
AC line power		
Rating voltage	100 to 240 V AC	
Voltage range		
90 ~ 250 V AC	48.0 to 63.0 Hz	
90 ~ 127 V AC	48.0 to 440 Hz	
Maximum power	300 W	
Maximum current	4 A	

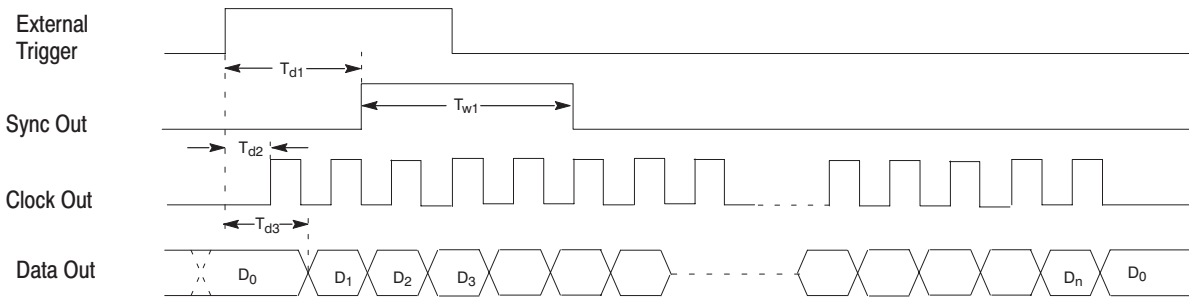

Figure A-1: Trigger delay

Table A-2: Warranted environmental characteristics

Characteristics	Description
Temperature	
Operating	+10 °C to +40 °C
Non operating	-20 °C to +60 °C
Relative humidity	
Operating	20% to 80% (No condensation) Maximum wet-bulb temperature 29.4 °C
Non operating	5% to 90% (No condensation) Maximum wet-bulb temperature 40.0 °C
Altitude	
Operating	To 4.5 km (15,000 feet). Maximum operating temperature decreases 1 °C each 300 m above 1.5 km.
Non operating	To 15 km (50,000 feet).
Dynamics	
Vibration	
Operating	0.33 mm _{p-p} , 10 to 55 Hz, 15 minutes
Shock	
Non operating	294 m/s ² (30 G), half-sine, 11 ms duration.
Installation requirements	
Power consumption (Fully loaded)	300 watts max. Maximum line current is 4 A rms at 50 Hz, 90 V line.
Surge current	30 A peak for < 5 line cycles, after product has been off for at least 30 s.
Cooling clearance	
Top clearance	1 inch
Side clearance	6 inches
Rear clearance	3 inches

Typical Characteristics

This section will describe the typical characteristics for the DG2020A. These values represent typical or average performance and are not absolutely guaranteed.

Table A-3: Electrical characteristics (typical)

Characteristics	Description
Clock generator	
Internal clock	
Period jitter	Measured by TDS694C-1MHD with TDSJIT1 Refer to Table A-4.
Cycle to cycle jitter	Measured by TDS694C-1MHD with TDSJIT1 Refer to Table A-5.
P3410 (TTL output pod)	
Data output	
Over / under shoot	< 0.5 V (into 1 M Ω 10 pF)
Rise / fall time	2 ns (20% to 80%, into 1 M Ω 10 pF)
Channel skew	< 3 ns (CH0 and other channels, same pod) < 2 ns (CH0 and CH0, two pods of same type)
Internal inhibit delay	-5 ns
Inhibit input	
Delay to data output	18 ns
P3420 (Variable output pod)	
Data output	
Output current	Total output current < 500 mA < -30 mA (Sink) > +30 mA (Source)
Over / under shoot	< \pm (5% of Swing) \pm 0.1 V (into 1 M Ω 10 pF)
Rise / fall time	2 ns (20% to 80%, into 1 M Ω 10 pF, 0 to 5 V swing)
Channel skew	< 3 ns (CH0 and other channels, same pod) < 2 ns (CH0 and CH0, two pods of same type)
Internal inhibit delay	-2 ns
Inhibit input	
Delay to data output	16 ns

Table A-3: Electrical characteristics (typical) (Cont.)

Characteristics	Description
P3420 (Variable output pod)	
Period jitter	Measured by TDS694C-1MHD with TDSJIT1 Refer to Table A-4.
Cycle to cycle jitter	Measured by TDS694C-1MHD with TDSJIT1 Refer to Table A-5.
Auxiliary outputs	
Sync output	
Duration	6 clocks (T_{W1} in Figure A-1)
Clock output	
Delay to data output	24 ns (P3410) 20 ns (P3420)
Auxiliary inputs	
External clock input	
Delay to P3410 data output	36 ns
Delay to P3420 data output	33 ns

Table A-4: Period Jitter

Clock frequency	200 MHz (When PLL to On.)		100 MHz (When PLL to On.)	
	StdDev	Pk-Pk	StdDev	Pk-Pk
Clock output	13.0 ps	70.0 ps	10.0 ps	60.0 ps
Data output (CH0 output)	6.0 ps	35.0 ps	5.5 ps	34.0 ps

Table A-5: Cycle to Cycle Jitter

Clock frequency	200 MHz (When PLL to On.)		100 MHz (When PLL to On.)	
	StdDev	Pk-Pk	StdDev	Pk-Pk
Clock output	20.0 ps	115.0 ps	17.0 ps	110.0 ps
Data output (CH0 output)	9.0 ps	52.0 ps	8.5 ps	50.0 ps

Nominal Traits

This section describes general characteristics of the DG2020A. These can be divided into two main categories: electrical characteristics and mechanical characteristics.

Table A-6: Nominal traits – electrical characteristics

Characteristics	Description
Output pattern	
Pattern length	64 word to 64 K word (non sequenced operation) 64 word to unlimited (sequenced operation)
Number of channels	Up to 12, 24 (Option 01), 36 (Option 02)
Memory capacity	
Pattern memory	64 K word × 12 bits 64 K word × 24 bits (Option 01) 64 K word × 36 bits (Option 02)
Sequence memory	2048 steps <i>NOTE: More than 2,048 lines can be input in the Sequence table. However, only first 2,048 steps expanded in the sequence memory are effective when executed.</i>
NV RAM	0.5 M bytes
Clock generator	
Internal clock	
Frequency	0.1 Hz to 200 MHz
Resolution	4 digits
Reference oscillator	
Frequency	10 MHz
P3410 (TTL output pod)	
Data output	
Impedance	50 Ω
Delay channel	CH8, CH9, CH10 and CH11
Delay time	0 to 20 ns
Delay resolution	0.1 ns
Event input	
Level	TTL
Impedance	1 kΩ
Setup time to next block	47 clock to 54 clock

Table A-6: Nominal traits – electrical characteristics (Cont.)

Characteristics	Description
P3410 (TTL output pod)	
Inhibit input	
Level	TTL
Impedance	1 k Ω
P3420 (Variable output pod)	
Data output	
Output impedance	50 Ω
Output voltage	
V _{OH}	-2.0 V to +7.0 V into 1 M Ω
V _{OL}	-3.0 V to +6.0 V into 1 M Ω
Resolution	0.1 V
Maximum swing	9.0 V _{p-p}
Minimum swing	0.5 V _{p-p}
Delay channel	CH8, CH9, CH10 and CH11
Delay time	0 to 20 ns
Delay resolution	0.1 ns
Event input	
Threshold	
Level	-5.0 V to +5.0 V
Resolution	0.1 V
Impedance	1 k Ω
Setup time to next block	47 clock to 54 clock
Inhibit input	
Threshold	
Level	-5.0 V to +5.0 V
Resolution	0.1 V
Impedance	1 k Ω

Table A-6: Nominal traits – electrical characteristics (Cont.)

Characteristics	Description	
Auxiliary outputs		
SYNC output		
Level	Positive TTL pulse $2.4\text{ V} < V_{OH} < 5.0\text{ V}$ (into 1 M Ω) $0\text{ V} < V_{OL} < 0.5\text{ V}$ (into 1 M Ω)	
Output resistance	50 Ω	
Connector	BNC (at front panel)	
EVENT output		
Level	Positive TTL pulse $2.4\text{ V} < V_{OH} < 5.0\text{ V}$ (into 1 M Ω) $0\text{ V} < V_{OL} < 0.5\text{ V}$ (into 1 M Ω)	
Delay time	22 clocks before Data Output change	
Duration	8 clocks	
Output resistance	50 Ω	
Connector	BNC (at front panel)	
CLOCK output		
Output resistance	50 Ω	
Connector	SMB (at rear panel)	
Auxiliary inputs		
TRIGGER input		
Threshold		
Level	-5.0 V to +5.0 V	
Resolution	0.1 V	
Impedance	1 k Ω or 50 Ω (selectable)	
Connector	BNC (at front panel)	
Data output delay uncertainty	Clock Setting	Delay Uncertainty
	Internal Clock, PLL:ON	5 ns to 10 ns
	Internal Clock, PLL:OFF	None
	External Clock	1 clock period
External clock input		
Impedance	50 Ω , terminated to +0.5 V	
Connector	SMB (at rear panel)	

Table A-6: Nominal traits - electrical characteristics (Cont.)

Characteristics	Description
Display	
Display area	5.2 inches (width) × 3.9 inches (height)
Resolution	640 (H) × 480 (V) pixels
Power source	
AC line power Fuse Rating	6A FAST, 250 V, UL 198G (3AG) 5A (T), 250 V, IEC 127
Battery Type	Li3 V, 650 mAH

Table A-7: Nominal traits – mechanical characteristics

Characteristics	Description
DG2020A	
Net weight	
Standard	9.7 kg
Dimensions	
Height	6.4 inches including feet
Width	14.3 inches including handle
Length	19.25 inches including front cover 22.2 inches with handle extended
P3410 (TTL output pod)	
Net weight	0.5 kg (excluding cables)
Dimensions	
Height	2.0 inches including feet
Width	5.9 inches
Length	4.0 inches
P3420 (Variable output pod)	
Net weight	1.0 kg (excluding cables)
Dimensions	
Height	2.0 inches including feet
Width	10.0 inches
Length	6.3 inches
Pod cable	
Length	1.2 m

Certification and Compliances

The certification and compliances for the DG2020A are listed in Table A-8.

Table A-8: Certifications and compliances

Category	Standards or description																				
EC Declaration of Conformity – EMC	<p>Meets intent of Directive 89/336/EEC for Electromagnetic Compatibility. Compliance was demonstrated to the following specifications as listed in the Official Journal of the European Communities:</p> <p>EMC Directive 89/336/EEC:</p> <table> <tr> <td>EN 55011</td> <td>Class A Radiated and Conducted Emissions</td> </tr> <tr> <td>EN 50081-1 Emissions:</td> <td></td> </tr> <tr> <td>EN61000-3-2</td> <td>AC Power Line Harmonic Emissions</td> </tr> <tr> <td>EN 50082-1 Immunity:</td> <td></td> </tr> <tr> <td>EN61000-4-2</td> <td>Electrostatic Discharge Immunity</td> </tr> <tr> <td>EN61000-4-3</td> <td>RF Electromagnetic Field Immunity</td> </tr> <tr> <td>EN61000-4-4</td> <td>Electrical Fast Transient/Burst Immunity</td> </tr> <tr> <td>EN61000-4-6</td> <td>Conducted Disturbance Induced by Radio-frequency Field</td> </tr> <tr> <td>EN61000-4-8</td> <td>Power Frequency Electromagnetic Field Immunity</td> </tr> <tr> <td>EN61000-4-11</td> <td>Voltage Dips and Interruptions Immunity</td> </tr> </table>	EN 55011	Class A Radiated and Conducted Emissions	EN 50081-1 Emissions:		EN61000-3-2	AC Power Line Harmonic Emissions	EN 50082-1 Immunity:		EN61000-4-2	Electrostatic Discharge Immunity	EN61000-4-3	RF Electromagnetic Field Immunity	EN61000-4-4	Electrical Fast Transient/Burst Immunity	EN61000-4-6	Conducted Disturbance Induced by Radio-frequency Field	EN61000-4-8	Power Frequency Electromagnetic Field Immunity	EN61000-4-11	Voltage Dips and Interruptions Immunity
EN 55011	Class A Radiated and Conducted Emissions																				
EN 50081-1 Emissions:																					
EN61000-3-2	AC Power Line Harmonic Emissions																				
EN 50082-1 Immunity:																					
EN61000-4-2	Electrostatic Discharge Immunity																				
EN61000-4-3	RF Electromagnetic Field Immunity																				
EN61000-4-4	Electrical Fast Transient/Burst Immunity																				
EN61000-4-6	Conducted Disturbance Induced by Radio-frequency Field																				
EN61000-4-8	Power Frequency Electromagnetic Field Immunity																				
EN61000-4-11	Voltage Dips and Interruptions Immunity																				
Australian/New Zealand declaration of Conformity - EMC	<p>Complies with EMC provision of Radio-communications Act per the following standard:</p> <table> <tr> <td>AS/NZS 2064.1/2</td> <td>Industrial, Scientific, and Medical Equipment: 1992</td> </tr> </table>	AS/NZS 2064.1/2	Industrial, Scientific, and Medical Equipment: 1992																		
AS/NZS 2064.1/2	Industrial, Scientific, and Medical Equipment: 1992																				
EC Declaration of Conformity – Low Voltage	<p>Compliance was demonstrated to the following specification as listed in the Official Journal of the European Communities:</p> <p>Low Voltage Directive 73/23/EEC, amended by 93/68/EEC</p> <table> <tr> <td>EN 61010-1/A1:1992</td> <td>Safety requirements for electrical equipment for measurement, control and laboratory use.</td> </tr> </table>	EN 61010-1/A1:1992	Safety requirements for electrical equipment for measurement, control and laboratory use.																		
EN 61010-1/A1:1992	Safety requirements for electrical equipment for measurement, control and laboratory use.																				
Approvals	<p>Complies with the following safety standards:</p> <table> <tr> <td>UL3111-1¹, First Edition</td> <td>Standard for electrical measuring and test equipment.</td> </tr> <tr> <td>CAN/CSA C22.2 No.1010.1-92¹</td> <td>Safety requirements for electrical equipment for measurement, control and laboratory use.</td> </tr> </table>	UL3111-1 ¹ , First Edition	Standard for electrical measuring and test equipment.	CAN/CSA C22.2 No.1010.1-92 ¹	Safety requirements for electrical equipment for measurement, control and laboratory use.																
UL3111-1 ¹ , First Edition	Standard for electrical measuring and test equipment.																				
CAN/CSA C22.2 No.1010.1-92 ¹	Safety requirements for electrical equipment for measurement, control and laboratory use.																				
Installation Category Description	<p>Terminals on this product may have different installation (over-voltage) category designations. The installation categories are:</p> <table> <tr> <td>Category</td> <td>Examples of products in this category</td> </tr> <tr> <td>CAT III</td> <td>Distribution-level mains (usually permanently connected). Equipment at this level is typically in a fixed industrial location.</td> </tr> <tr> <td>CAT II</td> <td>Local-level mains (wall sockets). Equipment at this level includes appliances, portable tools, and similar products. Equipment is usually cord-connected.</td> </tr> <tr> <td>CAT I</td> <td>Secondary (signal level) or battery operated circuits of electronic equipment.</td> </tr> </table>	Category	Examples of products in this category	CAT III	Distribution-level mains (usually permanently connected). Equipment at this level is typically in a fixed industrial location.	CAT II	Local-level mains (wall sockets). Equipment at this level includes appliances, portable tools, and similar products. Equipment is usually cord-connected.	CAT I	Secondary (signal level) or battery operated circuits of electronic equipment.												
Category	Examples of products in this category																				
CAT III	Distribution-level mains (usually permanently connected). Equipment at this level is typically in a fixed industrial location.																				
CAT II	Local-level mains (wall sockets). Equipment at this level includes appliances, portable tools, and similar products. Equipment is usually cord-connected.																				
CAT I	Secondary (signal level) or battery operated circuits of electronic equipment.																				

Table A-8: Certifications and compliances (cont.)

Category	Standards or description
Pollution Degree	<p>A measure of the contaminants that could occur in the environment around and within a product. Typically the internal environment inside a product is considered to be the same as the external. Products should be used only in the environment for which they are rated.</p> <p>Pollution Degree 2 Normally only dry, nonconductive pollution occurs. Occasionally a temporary conductivity that is caused by condensation must be expected. This location is a typical office/home environment. Temporary condensation occurs only when the product is out of service.</p>
Conditions of Approval	<p>Safety Certifications/Compliances are made for the following conditions:</p> <p>Altitude (maximum operation): 2000 meters</p>
IEC Characteristics	<p>Equipment type:</p> <p>Test and Measuring Installation Category II (as defined in IEC 61010-1, Annex J) Pollution Degree 2 (as defined in IEC 61010-1) Safety Class I (as defined in IEC 61010-1, Annex H)</p>

¹ CSA-C22.2 No.1010.1, UL3111-1, IEC61010-1 Safety Certification Compliance:
Altitude (maximum operating): 2000 meters

Appendix B: Performance Verification

This section describes the operation tests for the DG2020A data generator and the P3410 and P3420 pods, and the procedures for those tests. The operation tests can be divided into two categories.

- Self Tests. The DG2020A incorporates a diagnostic system that performs comprehensive instrument testing. This system confirms that the DG2020A is operating correctly. The self tests execute quickly and require no special equipment during execution.
- Performance Tests. There are 3 performance test groups.

Performance tests for the DG2020A plus pod combination

Performance tests for the P3410 pod

Performance tests for the P3420 pod

These tests confirm the operation of the items that are marked with an asterisk (*) in the guaranteed items in the operating specifications listed in Appendix A, "Performance Characteristics". The equipment listed in Table B-2 is required to perform these performance tests.

Before Running the Operation Tests

Perform the following before running the Operation Tests.

Warm up A 20 minute warm up period is required prior to running the operation tests.

File Loading The performance check disk provided with the DG2020A includes the files listed in Table B-1. The specified file must be loaded into the DG2020A for each operation test item. These files include pattern data and setup information.

Table B-1: Performance check disk's file list

File name	Operation test	Unit tested
TP1CLK.PDA	Internal clock frequency	DG2020A
TP2EXCLK.PDA	External clock input	DG2020A
TP3DPOUT.PDA	Digital output	DG2020A
TP4TRIG.PDA	External trigger operation	DG2020A
TP5EVENT.PDA	Event operation Event input and inhibit input	DG2020A, P3410, P3420
TP6DCTTL.PDA	Output voltage level	P3410
TP7DELAY.PDA	Variable delay	P3410, P3420
TP8DCH.PDA	Output voltage level	P3420
TP9DCL.PDA	Output voltage level	P3420

Use the following procedure to load the file required by a performance test into the instrument.

1. Insert the performance check disk into the DG2020A's floppy disk drive.
2. Press **EDIT** button from the **MENU** buttons.
3. Select **File** from the bottom menu.
4. Select **Load Data & Setup** from the side menu.
5. Select the required file using the general purpose knob.
6. Select **OK** from the sub menu.

Required Equipment Table B-2 lists the equipment required for the performance tests.

Table B-2: Required equipment

Item	No.	Required precision	Recommended equipment	Unit tested
Frequency counter	1	Frequency range: 0.1 Hz to 200 MHz Precision: 7 digits or higher	ANRITSU MF 1603A	DG2020A
Digital multimeter	1	DC voltage range: ± 10 V Precision: 0.01 V	Tektronix DM2510	P3410, P3420
Performance check disk	1		Tektronix part no. 063-1899-XX (provided with the DG2020A)	DG2020A P3410, P3420
Oscilloscope	1	Bandwidth: 500 MHz or higher	Tektronix TDS520, TDS540, or equivalent	DG2020A P3410, P3420
Function generator	1	Amplitude: 4 V, offset: 2 V (50 Ω termination), frequency: 1 MHz or higher	Tektronix AFG2020	DG2020A
Data generator	1		Tektronix DG2020A	P3410, P3420
Pod	1		Tektronix P3410 or P3420	DG2020A
SMB-to-pin-header cable	2	Impedance: 50 Ω Connector: SMB to pin header Length: 20 inches	Tektronix part no. 012-1503-00	DG2020A, P3410
SMB-to-BNC cable	2	Impedance: 50 Ω Connector: SMB to BNC Length: 40 inches	Tektronix part no. 012-1459-00	DG2020A, P3420
SMB to SMB cable	1	Impedance: 50 Ω Connector: SMB to SMB Length: 40 inches	Tektronix part no. 012-1458-00	DG2020A, P3420
BNC cable	2	Impedance: 50 Ω Connector: BNC Length: 24 inches	Tektronix part no. 012-1342-00	DG2020A
50 Ω termination	1	Impedance: 50 Ω	Tektronix part no. 011-0049-01	DG2020A
N-to-BNC adapter	1		Tektronix part no. 103-0045-00	DG2020A
SMB-to-BNC conversion adapter	2		Tektronix part no. 015-0671-00	DG2020A, P3410
BNC-dual-banana adapter	1		Tektronix part no. 103-0090-00	P3410, P3420
1 M Ω resistor	1	1 % tolerance	Tektronix part no. 321-0481-00	P3410, P3420
Pod connection cable	1		Tektronix part no. 174-3548-00 (provided with the DG2020A)	DG2020A P3410, P3420
T-connector	1		Tektronix part no. 103-0030-00	DG2020A

Test Procedure Notes

The following conventions are used in this manual for describing the self tests and performance tests.

- The test items are described in the following order.
 - Characteristic tested
 - Required equipment
 - Connections
 - Test procedure
- The test procedure is presented in order starting with step 1, and progresses through the end of the procedure. Tables such as the one shown below appear in these steps. For these steps, press the buttons in the order shown in the table, either from left to right or from top to bottom, to select the required menu item. For popup menus, use the general purpose knob to select items from the menu list. Operations such as operation 6 do not involve pressing the buttons shown in the row above, but rather are descriptions of operations to be performed. Figure B-1 shows the buttons used and the menu layout.

Menu button	Bottom button	Popup menu	Side button	Front panel button
Operation 1	Operation 2	Operation 3	Operation 4	Operation 5
Operation 6 (e.g., insert a disk in the disk drive.)				
			Operation 7	

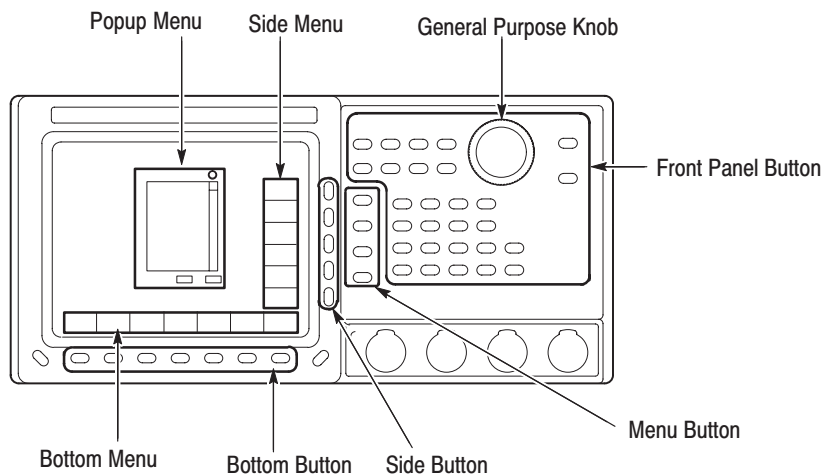

Figure B-1: Operating buttons and menu layout

Self Tests

Execute the DG2020A self tests and confirm that no errors occurred.

1. Press the required buttons in the following order. If **All** is selected as the **Type**, all test items will be run.

Menu button	Bottom button	Popup menu	Side button	Front panel button
UTILITY	Diag		Type (Select All.)	
			Execute	

2. Confirm that all items passed by checking the **Status** display area shown in Figure B-2.

Type	Status	Comment
* CPU	Pass	
* Display	Pass	
* Front-Panel	Pass	
* Clock	Pass	
* Trigger	Pass	
* Pattern Memory Unit0	Pass	
* Sequence Memory	Pass	

Figure B-2: Diagnostics menu

If **Fail** is displayed in the **Status** display area an error code will be displayed in the **Comment** column. See Table B-3 for the meanings of the error codes.

NOTE. Contact your Tektronix sales representative if an error occurs.

Table B-3: Error Codes

Error code	Error meaning	Failed component
1XX	CPU diagnostic error	A6 CPU board
2XX	Display diagnostic error	A6 CPU board
3XX	Front panel diagnostic error	A12 keyboard
4XX	Clock diagnostic/calibration error	A30 Clock board
5XX	Trigger diagnostic/calibration error	A30 Clock board
6XX	Sequence memory diagnostic error	A50/A51 PG board
7XX	Pattern memory diagnostic error	A50/A51 PG board

Performance Tests for the DG2020A/Pod Combination

The items in this performance test are for the DG2020A in combination with a pod. Perform these test items in the following order.

- Internal clock frequency B-6
- External clock input B-8
- Digital output B-9
- External trigger operation B-12
- Event operation B-14

Internal Clock Frequency

This test confirms the frequency precision of the DG2020A internal clock.

With the PLL circuit on: Clock frequency ± 50 ppm

With the PLL circuit off: Clock frequency $\pm 3\%$

Required Equipment

- Frequency counter
- SMB-to-BNC cable
- 50 Ω termination
- N-to-BNC adapter
- Performance check disk

Connections. Connect the clock output from the DG2020A rear panel to the frequency counter input (INPUT B) through the N-to-BNC adapter with the SMB-to-BNC cable.

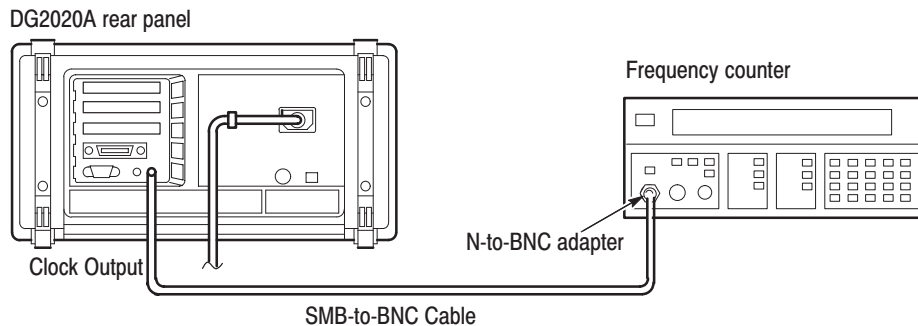

Figure B-3: Frequency measurement connections

Setup. Set the frequency counter to frequency measurement mode.

Characteristics Confirmation Procedure

1. Load the **TP1CLK.PDA** test pattern file from the performance check disk. When the file is loaded, the DG2020A clock frequency will be set to 200 MHz internally and the PLL circuit will be turned on.

The following two steps check the clock frequency precision with the PLL circuit on and the internal clock frequency set to 200 MHz

2. Press the **START/STOP** button on the front panel so that the button's LED indicator lights.
3. Set the counter trigger to an appropriate value and confirm that the counter displays a frequency in the range 199.99 to 200.01 MHz.

The following five steps check the clock frequency precision with the PLL circuit on and the internal clock frequency set to 200 kHz or 100.0 mHz.

4. Change the frequency counter input to INPUT A through the 50 Ω termination with the SMB-to-BNC cable.
5. Press the following buttons to set the DG2020A clock frequency to 200 kHz.

Menu button	Bottom button	Popup menu	Side button	Front panel button
SETUP	Oscillator		Int Frequency	2,0,0,kHz/ms/mV

6. Set the counter trigger to an appropriate value, and confirm that the counter displays a frequency in the range 199.99 to 200.01 kHz.
7. Set the DG2020A clock frequency to 100 mHz.
8. Set the frequency counter to frequency measurement mode.
9. Set the counter trigger to an appropriate value, and confirm that the counter displays a frequency in the range 99.995 to 100.005 mHz.

The following two steps check the clock frequency precision with the PLL circuit off and the internal clock frequency set to 200 MHz, 200 kHz and 100.0 mHz.

10. Press the following buttons to turn the PLL circuit off.

Menu button	Bottom button	Popup menu	Side button	Front panel button
SETUP	Oscillator		PLL (Set to Off.)	

11. Set the internal clock frequency to 200 MHz, 200 kHz, and 100.0 mHz, and confirm that the frequencies and periods measured by the frequency counter fall within the ranges shown in Table B-4.

Table B-4: Internal clock frequency precision (PLL off)

Internal clock frequency (Int Frequency)	Clock frequency range
200.0 MHz	194 MHz to 206 MHz
200.0 kHz	194 kHz to 206 kHz
100.0 mHz (10.0 s)	97 mHz to 103 mHz (9.709 s to 10.31 s)

External Clock Input

This test confirms external clock input operation. Confirm that the clock signal is output from the **CLOCK OUT** connector when a square wave signal with a frequency of 1 MHz and an amplitude of 1 V ($V_{IH} > 0.7\text{ V}$, $V_{IL} < 0.3\text{ V}$) is input as an external clock signal.

Required Equipment

- Oscilloscope
- Function generator
- Two SMB-to-BNC cables
- Performance check disk

Connections. Connect the clock output from the DG2020A rear panel to the oscilloscope CH1 input with an SMB-to-BNC cable. Connect the function generator output to the DG2020A rear panel clock input with the other SMB-to-BNC cable.

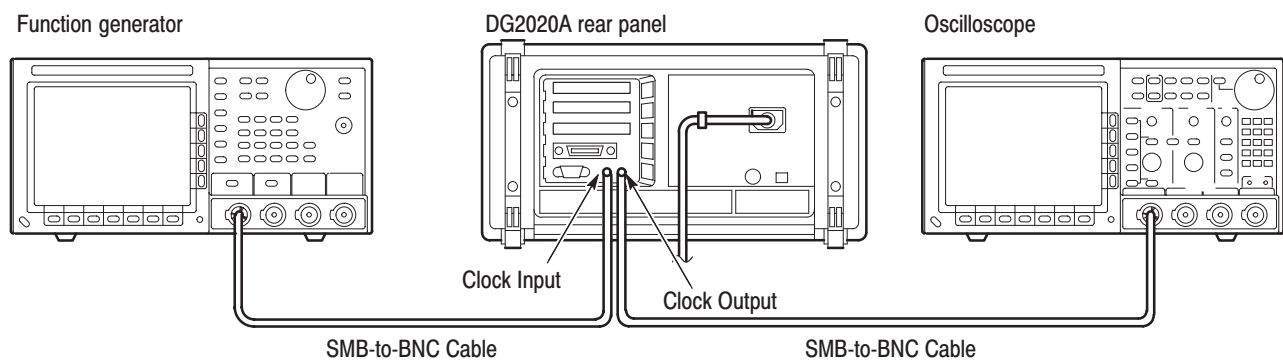

Figure B-4: External clock input connection

Setup

■ Oscilloscope

Displayed channel CH1
 Vertical axis 500 mV/div
 Horizontal axis 1 μ s/div
 Trigger mode Auto
 Trigger level 500 mV
 Input coupling DC
 Input impedance 50 Ω

■ Function generator

Waveform Square wave
 Frequency 1 MHz
 Amplitude 1 V (50 Ω termination)
 Offset 500 mV (50 Ω termination)

Characteristics Confirmation Procedure

1. Load the **TP2EXCLK.PDA** test pattern file from the performance check disk.
2. Press the **START/STOP** button on the front panel so that the button's LED indicator lights.
3. Confirm that the clock pulse waveform can be observed on the oscilloscope.

Digital Output

This test confirms that pattern data is output from the pod data outputs (CH0 through CH11).

Required Equipment

- Oscilloscope
- P3410 or P3420 pod
- Pod connection cable
- SMB-to-pin-header cable (when a P3410 pod is used)
- SMB to BNC adapter (when a P3410 pod is used)
- SMB-to-BNC cable (when a P3420 pod is used)
- Performance check disk

Connections. Connect the DG2020A rear panel pattern data output-connector (POD A) to the data input-connector on the rear panel of a P3410 or P3420 pod using a pod connection cable.



CAUTION. When connecting the DG2020A to a pod with a pod connection cable, turn off the DG2020A power before connecting the cable. Connecting the cable with the power in the on state can damage the DG2020A and the P3410 pod. When attaching the pod cable, ensure that the plug and socket are aligned correctly.

Make sure that you have correctly inserted the cable plug in the DG2020A and the pod before turning on power. The yellow wire end of the connector must be aligned with the triangular yellow index mark on the DG2020A or pod. Incorrectly connected cables will damage the DG2020A and the pod.

For more details, refer to page 1-9.

Next, connect the pod CH0 signal output to the oscilloscope CH1 input using an SMB-to-pin-header cable and an SMB to BNC adapter (for a P3410 pod) or an SMB-to-BNC cable (for a P3420 pod). See Figure B-5 for the general method of connection. Also, see Figures B-6 and B-7 for detailed views of the pod data output connectors.

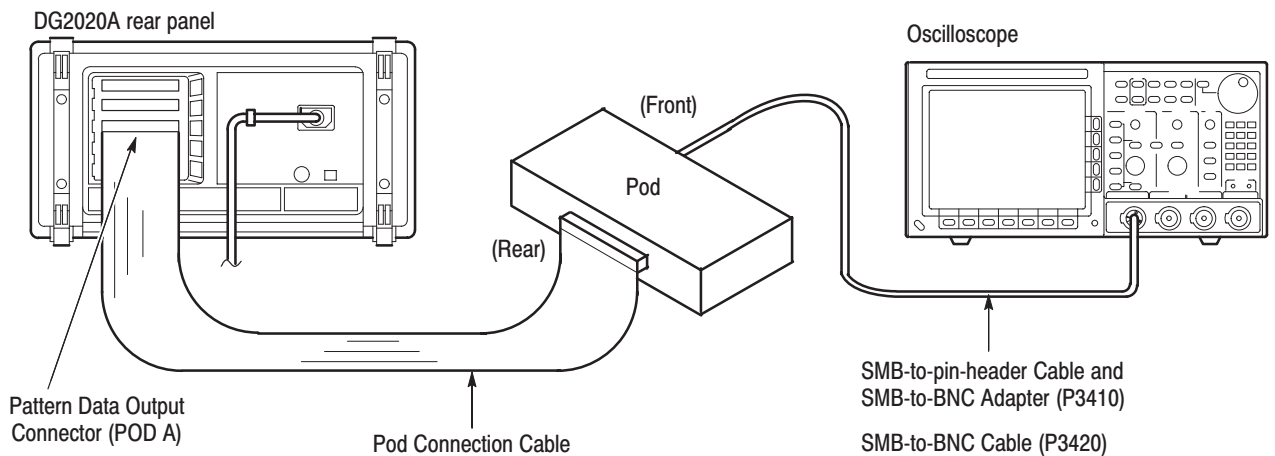

Figure B-5: Pod connection

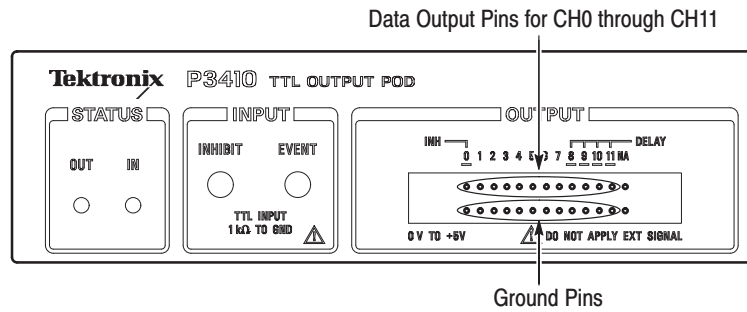

Figure B-6: P3410 data output connectors

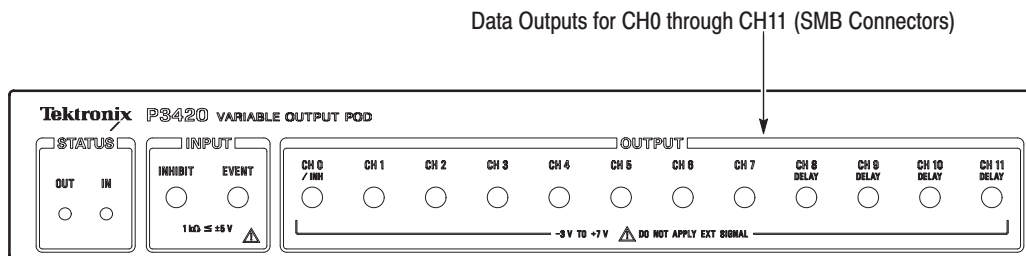

Figure B-7: P3420 data output connectors

Setup

- Oscilloscope

Displayed channel CH1
 Vertical axis 2 V/div
 Horizontal axis . . . 5.0 ns/div
 Trigger mode Auto
 Trigger level 2 V
 Input coupling DC
 Input impedance . . 1 M Ω

Characteristics Confirmation Procedure

1. Load the **TP3DPOUT.PDA** test pattern file from the performance check disk.
2. Press the **START/STOP** button on the front panel so that the button's LED indicator lights.
3. Confirm that the clock pulse waveform can be observed on the oscilloscope. This clock pulse is output by the **EDIT** screen **DATA35** data pattern.
4. Switch the SMB-to-pin-header cable (P3410) or SMB-to-BNC cable (P3420) to the pod CH1 output.

5. Confirm that the clock pulse waveform can be observed on the oscilloscope. This clock pulse is output by the **EDIT** screen DATA34 data pattern.
6. Repeat steps 4 and 5 for the pod outputs CH2 through CH11. Confirm that the DATA33 to DATA24 data patterns are output from these channels respectively.
7. If the option 01 (24 channels) or the option 02 (36 channels) is installed, repeat this procedure for POD B and POD C.

External Trigger Operation

This test confirms that pattern data output is started by an external trigger signal.

Required Equipment

- Oscilloscope
- Function generator
- P3410 or P3420 pod
- Pod connection cable
- SMB-to-pin-header cable (when a P3410 pod is used)
- SMB to BNC adapter (when a P3410 pod is used)
- SMB-to-BNC cable (when a P3420 pod is used)
- Two BNC cables
- T-connector
- Performance check disk

Connections. The pod is connected in the same way as shown in Figure B-5. Additionally, use the T-connector and BNC cables to connect the function generator output to the DG2020A trigger input connector and to the oscilloscope CH2 input as shown in Figure B-8.

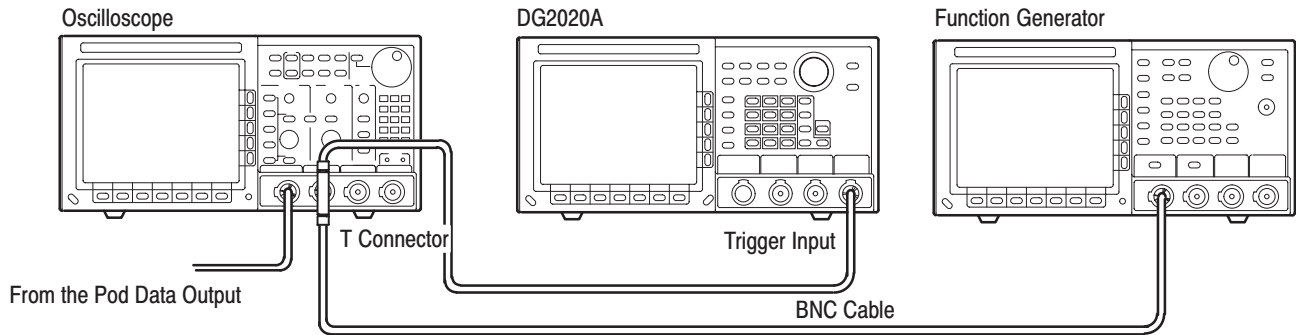

Figure B-8: External trigger operation connections

Setup

■ Oscilloscope

- Displayed channels CH1 and CH2
- Vertical axis (CH1 and CH2) 2 V/div
- Horizontal axis 200 ns/div
- Trigger mode Auto
- Trigger level 2 V
- Trigger source CH2
- Input coupling DC
- Input impedance (CH1 and CH2) 1 MΩ

■ Function generator

- Waveform Square wave
- Frequency 1 MHz
- Amplitude 4 V (50 Ω termination)
- Offset 2 V (50 Ω termination)

Characteristics Confirmation Procedure

1. Load the **TP4TRIG.PDA** test pattern file from the performance check disk.
2. Press the **START/STOP** button on the front panel so that the button’s LED indicator lights.
3. Confirm that the function generator output signal (the oscilloscope CH2 signal) and a square wave synchronized with this signal (the oscilloscope CH1 signal) are displayed on the oscilloscope.

Event Operation This test confirms event jump operation. It confirms that a synchronization signal and an event signal are output at the same time.

Required Equipment

- Oscilloscope
- P3410 or P3420 pod
- Pod connection cable
- Two SMB-to-pin-header cables (when a P3410 pod is used)
- SMB to BNC adapter (when a P3410 pod is used)
- SMB-to-BNC cable (when a P3420 pod is used)
- SMB to SMB cable (when a P3420 pod is used)
- Performance check disk

Connections. The connections for this test are the same as shown in Figure B-5.

Setup

- Oscilloscope
 - Displayed channel CH1
 - Vertical axis 2 V/div
 - Horizontal axis . . . 200 ns/div
 - Trigger mode Auto
 - Trigger source CH1
 - Trigger level 1.5 V
 - Input coupling DC
 - Input impedance . . 1 MΩ
 - Hold Off 9 μs

Characteristics Confirmation Procedure

The following steps confirm event jump operation.

1. Load the **TP5EVENT.PDA** test pattern file from the performance check disk.
2. Press the **START/STOP** button on the front panel so that the button's LED indicator lights.
3. Confirm that a square wave with a 1 μs period is displayed on the oscilloscope.
4. Press the front panel **STEP/EVENT** button.
5. Confirm that a square wave with a 500 ns period is displayed on the oscilloscope.

6. Confirm that square waves with 1 μ s and 500 ns periods are displayed on the oscilloscope alternately each time the front panel **STEP/EVENT** button is pressed.
7. Connect the pod data output CH1 to the pod **EVENT INPUT**. Use an SMB-to-pin-header cable for the P3410 pod and an SMB to SMB cable for the P3420 pod. See Figures B-9 and B-10.

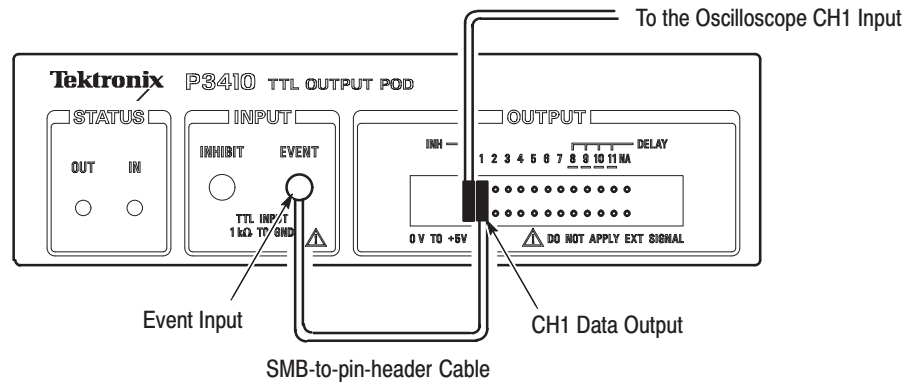

Figure B-9: P3410 event input connections

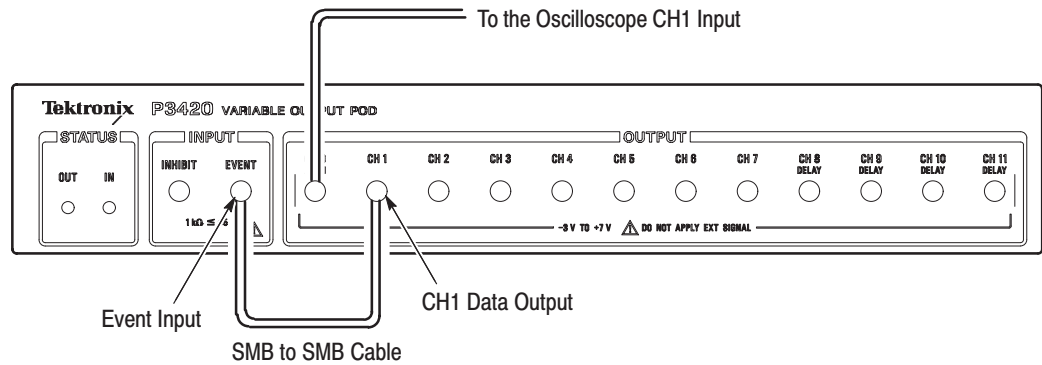

Figure B-10: P3420 event input connections

8. Confirm that a 1 μ s square wave and a 500 ns square wave are displayed on the oscilloscope alternately for 1 cycle and 2 cycles respectively.

The following three steps confirm the event output signal operation.

9. Connect the DG2020A **EVENT OUTPUT** to the oscilloscope's CH2 with a BNC cable.

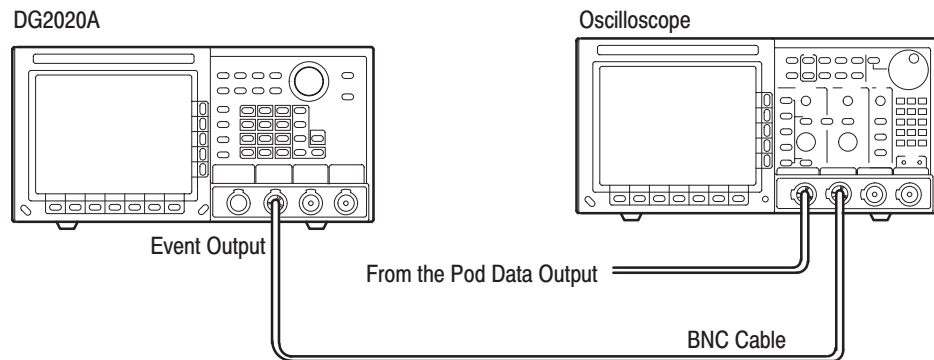

Figure B-11: DG2020A event output connections

10. Switch the oscilloscope display channel from CH1 to CH2.

11. Confirm that the event output signal is displayed on the oscilloscope.

The following two steps confirm the synchronization output signal operation.

12. Switch the BNC cable from the DG2020A **EVENT OUTPUT** connector to the **SYNC OUTPUT** connector.

13. Confirm that the synchronization signal appears on the oscilloscope.

P3410 Pod Performance Test

The items in this performance test are only for the P3410 pod. Perform these test items in the following order.

- Output voltage levels B-19
- Variable delay B-20
- Event input and inhibit input B-22

P3410 Pod Installation

Perform the following procedures to install the P3410.

1. Connect the DG2020A rear panel pattern data output connector to the P3410 rear panel data input connector using a pod connection cable. See Figure B-12.



CAUTION. When connecting the DG2020A to a pod with a pod connection cable, turn off the DG2020A power before connecting the cable. Connecting the cable with the power in the on state can damage the DG2020A and the P3410 pod. When attaching the pod cable, ensure that the plug and socket are aligned correctly.

Make sure that you have correctly inserted the cable plug in the DG2020A and the pod before turning on power. The yellow wire end of the connector must be aligned with the triangular yellow index mark on the DG2020A or pod. Incorrectly connected cables will damage the DG2020A and the pod.

For more details, refer to page 1-9.

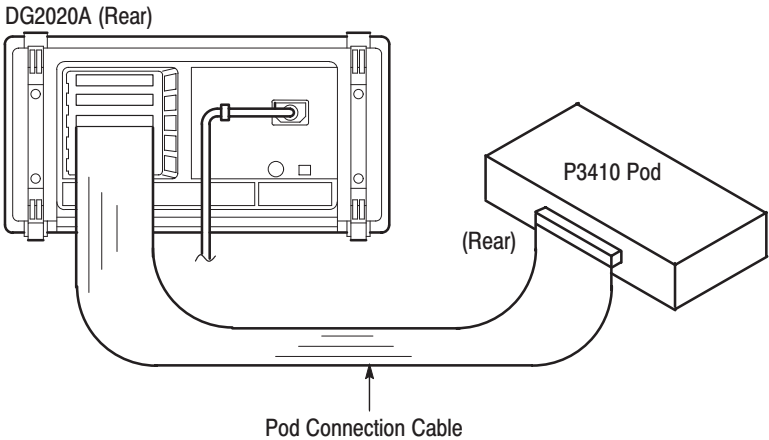

Figure B-12: Pod connection

2. Turn on the DG2020A power.
3. Press the DG2020A **SETUP** button. Confirm that TTL high (HI) and TTL low (LO) are displayed in the voltage level column on the DG2020A screen. (See Figure B-13.)

Voltage Level Display

Channel	Data [Group:Bit]	High	Low	Delay	Inhibit
A-00	D00 [DATA00:00]	TTL-HI	TTL-LO	-----	OFF
A-01	D01 [DATA01:00]	TTL-HI	TTL-LO	-----	OFF
A-02	D02 [DATA02:00]	TTL-HI	TTL-LO	-----	OFF
A-03	D03 [DATA03:00]	TTL-HI	TTL-LO	-----	OFF
A-04	D04 [DATA04:00]	TTL-HI	TTL-LO	-----	OFF
A-05	D05 [DATA05:00]	TTL-HI	TTL-LO	-----	OFF
A-06	D06 [DATA06:00]	TTL-HI	TTL-LO	-----	OFF
A-07	D07 [DATA07:00]	TTL-HI	TTL-LO	-----	OFF
A-08	D08 [DATA08:00]	TTL-HI	TTL-LO	0.0 ns	OFF
A-09	D09 [DATA09:00]	TTL-HI	TTL-LO	0.0 ns	OFF
A-10	D10 [DATA10:00]	TTL-HI	TTL-LO	0.0 ns	OFF
A-11	D11 [DATA11:00]	TTL-HI	TTL-LO	0.0 ns	OFF

Figure B-13: P3410 voltage level display

P3410 Output Pins and Pin Header Cables

Refer to Figure B-14 when connecting a pin header cable to a P3410 output pins. There are two types of pin header with different shapes. (See Figure B-15.) Check which header pin you are using carefully.

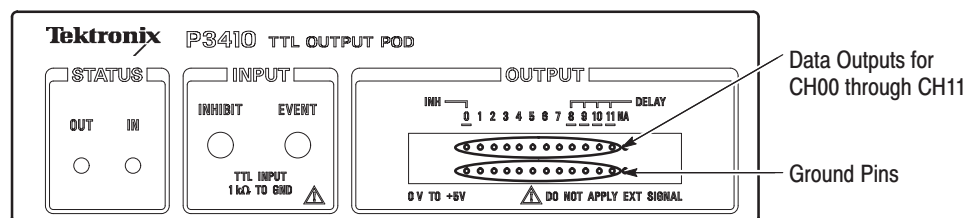

Figure B-14: P3410 output pins

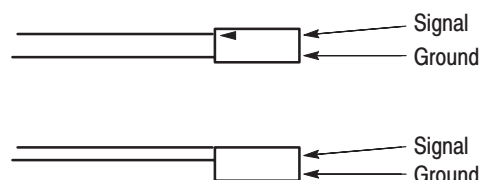

Figure B-15: Pin header cable types

Output Voltage Levels

This test confirms the pod output voltages into a 1 MΩ load.

High level . . . 4.4 V or higher

Low level . . . 0.1 V or lower

Required Equipment

- DG2020A
- Pod connection cable
- BNC to dual banana adapter
- SMB-to-pin-header cable
- SMB to BNC adapter
- 1 MΩ resistor
- Performance check disk

Connections. Connect the CH0 data output pin for the pod connected to the DG2020A to the digital multimeter input through an SMB-to-pin-header cable, and SMB to BNC adapter, and a BNC to dual banana adapter. Connect the 1 MΩ resistor across the BNC to dual banana adapter terminals.

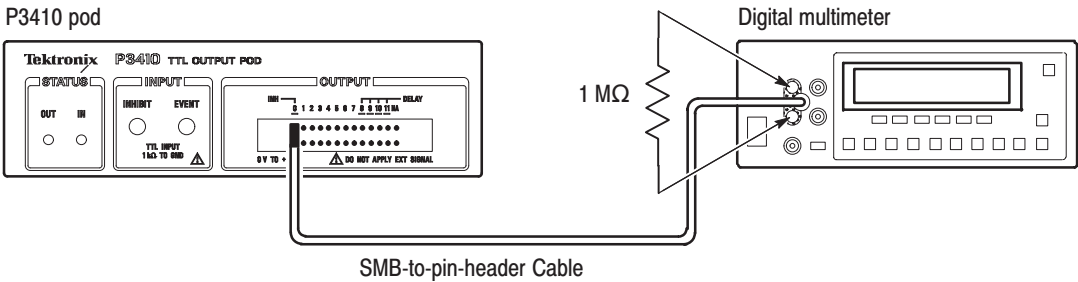

Figure B-16: Output voltage test connections

Setup

- Digital multimeter
 - Function DCV
 - Range Auto

Characteristics Confirmation Procedure

1. Load the **TP6DCTTL.PDA** test pattern file from the performance check disk.

2. Press the **START/STOP** button on the front panel so that the button's LED indicator lights.
3. Confirm that the digital multimeter display reads 0.1 V (the low level) or lower.
4. Press the front panel **FORCE TRIGGER** button.
5. Confirm that the digital multimeter display reads 4.4 V (the high level) or higher.
6. Move the pin header cable connected to the P3410 CH0 output pin to the CH1 pin and repeat steps 3 through 5. Confirm the output levels for CH2 through CH11 in the same manner.

Variable Delay

This test confirms that accuracy of the delay relative to CH0 in the P3410 is within the range ± 2 ns. This test is for the channels that support variable delay times, i.e., channels CH8 to CH11.

Required Equipment

- DG2020A
- Pod connection cable
- Oscilloscope
- Two SMB-to-pin-header cables
- Two SMB to BNC adapters
- Performance check disk

Connections. Connect the P3410 CH0 and CH8 data output pins to the oscilloscope CH1 and CH2 inputs, respectively, using the SMB-to-pin-header cables and the SMB to BNC adapters.

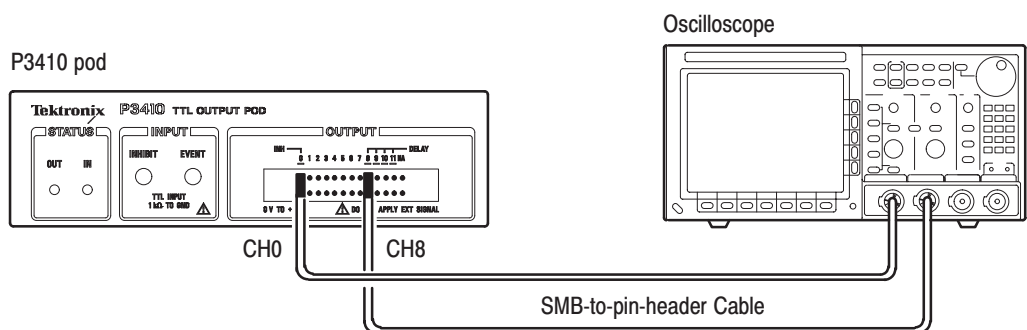

Figure B-17: Variable delay test connections

Setup

- Oscilloscope
 - Displayed channels CH1 and CH2
 - Vertical axis
 - (CH1 and CH2) 2 V/div
 - Horizontal axis 2 ns/div
 - MEASURE CH1 → CH2 DLY
 - Record Length 2500 point in 50 divs
 - Trigger source CH1
 - Input coupling
 - (CH1 and CH2) DC
 - Input impedance
 - (CH1 and CH2) 1 MΩ

Characteristics Confirmation Procedure

1. Load the **TP7DELAY.PDA** test pattern file from the performance check disk.
2. Press the following buttons in the order shown. In this state the CH8 through CH11 delay settings will all be 0.0 ns.

Menu button	Bottom button	Popup menu	Side button	Front panel button
SETUP	Level/Delay			
Move the cursor to CH08 using the general purpose knob.				
			Delay	

3. Press the **START/STOP** button on the front panel so that the button’s LED indicator lights.
4. Observe the two clock pulses on the oscilloscope, and read off the CH8 delay value referenced to CH0 with the timing measured between points with voltages of 50 % of the peak value. Confirm that the values measured with the oscilloscope for the delay settings in Table B-5 fall within ranges in the table below.

Table B-5: Delay precision

Settings	Delay span range
0.0 ns	-2.0 ns to 2.0 ns
2.0 ns	0.0 ns to 4.0 ns
5.0 ns	3.0 ns to 7.0 ns

Table B-5: Delay precision (Cont.)

Settings	Delay span range
10.0 ns	8.0 ns to 12.0 ns
20.0 ns	18.0 ns to 22.0 ns

5. Move the pin header cable connected to the P3410 CH8 to channels CH9 through CH11 in order and repeat step 3 to confirm the delay values.

Event Input and Inhibit Input

This test confirms that the event jump and inhibit operations function correctly in response to signals applied to the P3410 pod event and inhibit inputs.

Required Equipment

- DG2020A
- Oscilloscope
- Pod connection cable
- Two SMB-to-pin-header cables
- SMB to BNC adapter
- Performance check disk

Connections. Connect the P3410 CH0 output pin to the oscilloscope CH1 input using an SMB-to-pin-header cable and an SMB to BNC adapter. Also connect the P3410 CH1 output pin to the P3410 **EVENT INPUT** using the other SMB-to-pin-header cable.

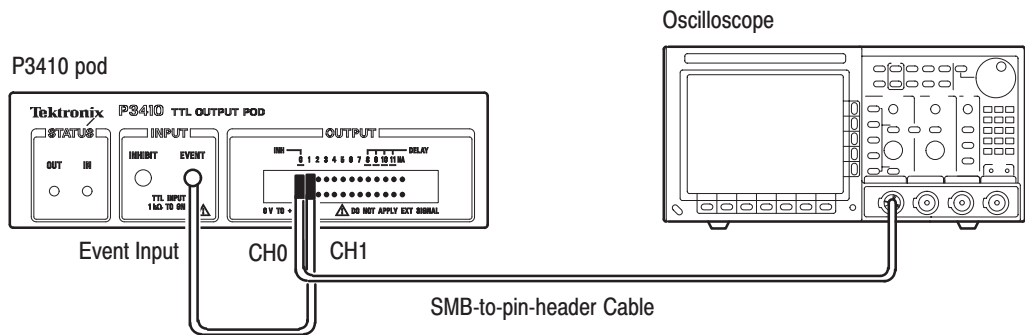

Figure B-18: Event input operation confirmation connections

Setup

■ Oscilloscope

Displayed channel CH1
 Vertical axis 2 V/div
 Horizontal axis . . . 200 ns/div
 Trigger mode Auto
 Trigger level 1.5 V
 Input coupling DC
 Hold off 9 μ s
 Input impedance . . 1 M Ω

Characteristics Confirmation Procedure

The following three steps confirm the event input operation.

1. Load the **TP5EVENT.PDA** test pattern file from the performance check disk.
2. Press the **START/STOP** button on the front panel so that the button's LED indicator lights.
3. Confirm that a 1 μ s square wave and a 500 ns square wave are displayed on the oscilloscope alternately for 1 cycle and 2 cycles respectively.

The following four steps confirm the inhibit input operation.

4. Remove the header pin connected to pod CH0 and connect it to CH2. Next, remove the header pin connected to CH1 and connect it to CH0. Remove the SMB connector connected to **EVENT INPUT** and connect it to **INHIBIT INPUT**.

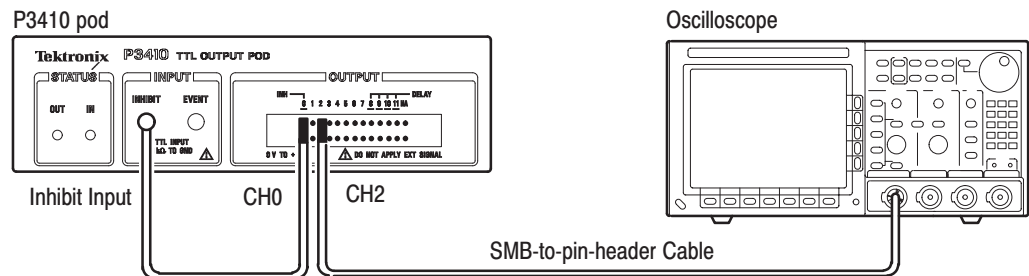

Figure B-19: Inhibit operation confirmation connections

5. Set the oscilloscope CH1 input impedance to 50 Ω .
6. Press the **START/STOP** button on the front panel twice.
7. Confirm that a square wave with a 1 μ s period is displayed on the oscilloscope.

P3420 Pod Performance Test

The items in this performance test are only for the P3420 pod. Perform these test items in the following order.

- Output voltage levels B-25
- Variable delay B-29
- Event input and inhibit input . B-31

P3420 Pod Installation

Perform the following procedures to install the P3420.

1. Connect the DG2020A rear panel pattern data output connector to the P3420 rear panel data input connector using a pod connection cable. See Figure B-20.



CAUTION. When connecting the DG2020A to a pod with a pod connection cable, turn off the DG2020A power before connecting the cable. Connecting the cable with the power in the on state can damage the DG2020A and the P3410 pod. When attaching the pod cable, ensure that the plug and socket are aligned correctly.

Make sure that you have correctly inserted the cable plug in the DG2020A and the pod before turning on power. The yellow wire end of the connector must be aligned with the triangular yellow index mark on the DG2020A or pod. Incorrectly connected cables will damage the DG2020A and the pod.

For more details, refer to page 1-9.

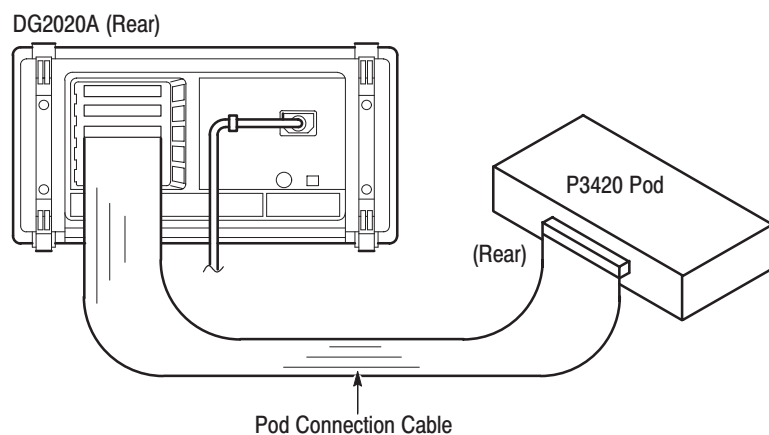

Figure B-20: Pod connection

2. Turn on the DG2020A power.
3. Press the DG2020A **SETUP** button. Confirm that the high and low level voltage values are displayed in the voltage levels column on the DG2020A screen. (See Figure B-21.)

Voltage Level Display

Channel	Data [Group:Bit]		High	Low	Delay	Inhibit
A-00	D00	DATA00:00	3.0 V	0.0 V	-----	OFF
A-01	D01	DATA01:00	3.0 V	0.0 V	-----	OFF
A-02	D02	DATA02:00	3.0 V	0.0 V	-----	OFF
A-03	D03	DATA03:00	3.0 V	0.0 V	-----	OFF
A-04	D04	DATA04:00	3.0 V	0.0 V	-----	OFF
A-05	D05	DATA05:00	3.0 V	0.0 V	-----	OFF
A-06	D06	DATA06:00	3.0 V	0.0 V	-----	OFF
A-07	D07	DATA07:00	3.0 V	0.0 V	-----	OFF
A-08	D08	DATA08:00	3.0 V	0.0 V	0.0 ns	OFF
A-09	D09	DATA09:00	3.0 V	0.0 V	0.0 ns	OFF
A-10	D10	DATA10:00	3.0 V	0.0 V	0.0 ns	OFF
A-11	D11	DATA11:00	3.0 V	0.0 V	0.0 ns	OFF

Figure B-21: P3420 voltage level display

P3420 Output Connections

Figure B-22 shows the output connections for the P3420.

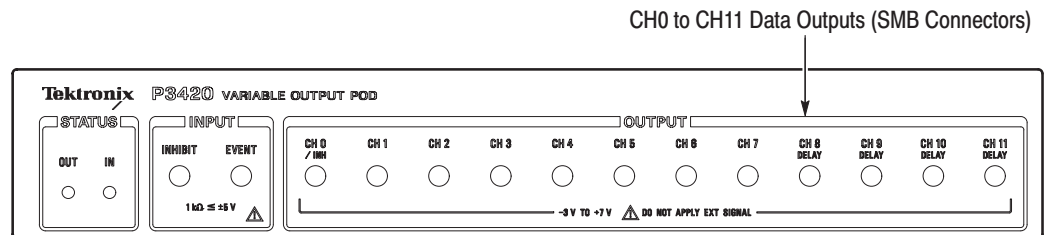

Figure B-22: P3420 output connectors

Output Voltage Levels

This test confirms pod output voltages into a 1 MΩ load.

Precision : ±(3% of Amplitude) ± 0.1 V

Variable voltage levels for the amplitude

High level: -2 V to +7 V

Low level: -3 V to +6 V

Required Equipment

- DG2020A
- Pod connection cable
- BNC to dual banana adapter
- SMB-to-BNC cable
- 1 M Ω resistor
- Performance check disk

Connections. Connect the CH0 data output pin for the pod connected to the DG2020A to the digital multimeter input through an SMB-to-BNC cable, and a BNC to dual banana adapter. Connect the 1 M Ω resistor across the BNC to dual banana adapter terminals.

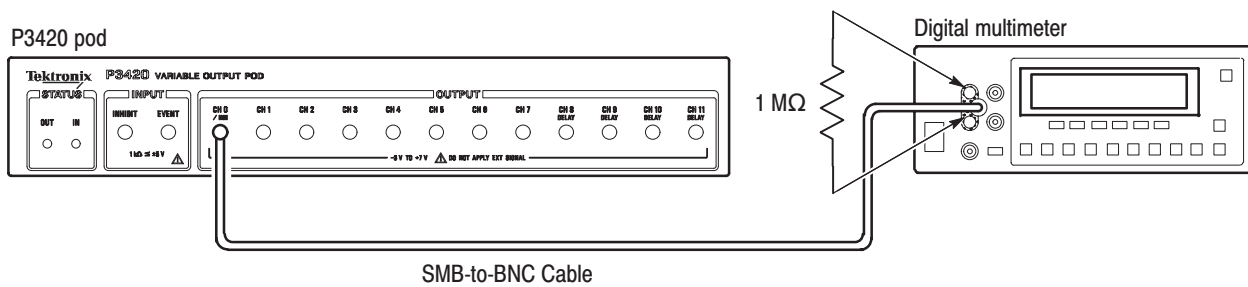

Figure B-23: Output voltage level measurement connections

Setup

- Digital multimeter
 - Function DCV
 - Range Auto

Characteristics Confirmation Procedure

The following six steps confirm the high level output voltage accuracy.

1. Load the **TP8DCH.PDA** test pattern file from the performance check disk.
2. Press the keys shown below in the indicated order to set the high level voltage to -2 V and the low level voltage to -3 V.

Menu button	Bottom button	Popup menu	Side button	Front panel button
SETUP	Level/Delay			
Move the cursor to CH00 with the general purpose knob.				
			High Level	-, 2, ENTER
			Low Level	-, 3, ENTER

3. Press the **START/STOP** button on the front panel so that the button's LED indicator lights.
4. Confirm that the reading on the digital multimeter is in the range -2.16 to -1.84 V.
5. Set the high level voltage to 0 V, 2.0 V, 4.0 V and 7.0 V as shown in Table B-6, and confirm that the digital multimeter reading falls within the specified voltage ranges. Note that the low level voltage is automatically set to -2 V when the high level voltage is set to 7 V.

Table B-6: High level output voltage ranges for a 1 M Ω load

Settings		High level output voltage range
High level	Low level	
0 V	-3.0 V	-0.10 V to 0.10 V
2.0 V	-3.0 V	1.84 V to 2.16 V
4.0 V	-3.0 V	3.78 V to 4.22 V
7.0 V	-2.0 V	6.69 V to 7.31 V

6. Move the SMB-to-BNC cable connected to the P3420 CH0 output connector to CH1 through CH11 in turn, and confirm the high level output voltage ranges in the same way for each of these channels.

The remaining steps confirm the low level output voltage accuracy.

7. Move the SMB-to-BNC cable connected to the P3420 data output connector back to CH0.
8. Load the **TP9DCL.PDA** test pattern file from the performance check disk.
9. Press the keys shown below in the indicated order to set the low level voltage to 6 V and the high level voltage to 7 V.

Menu button	Bottom button	Popup menu	Side button	Front panel button
SETUP	Level/Delay			
Move the cursor to CH00 with the general purpose knob.				
			Low Level	6, ENTER
			High Level	7, ENTER

10. Press the **START/STOP** button on the front panel so that the button's LED indicator lights.
11. Confirm that the reading on the digital multimeter is in the range 5.72 to 6.28 V.
12. Set the low level voltage to 4.0 V, 2.0 V, 0.0 V and -3.0 V as shown in Table B-7, and confirm that the digital multimeter reading falls within the specified voltage range. Note that the high level voltage is automatically set to 6 V when the low level voltage is set to -3 V.

Table B-7: Low level output voltage ranges for a 1 MΩ load

Settings		High level output voltage range
Low level	High level	
4.0 V	7.0 V	3.78 V to 4.22 V
2.0 V	7.0 V	1.84 V to 2.16 V
0.0 V	7.0 V	-0.10 V to 0.10 V
-3.0 V	6.0 V	-3.19 V to -2.81 V

13. Move the SMB-to-BNC cable connected the P3420 CH0 output connector to CH1 through CH11 in turn, and confirm the low level output voltage ranges in the same way for each of these channels.

Variable Delay

This test confirms that the delay with respect to the P3420 CH0 is within the range $\pm(0.8 \text{ ns} + 3\% \text{ of the delay time})$. This test is for the channels that support variable delay times, i.e., channels CH8 to CH11.

Required Equipment

- DG2020A
- Pod connection cable
- Oscilloscope
- Two SMB-to-BNC cables
- Performance check disk

Connections. Connect the P3420 CH0 and CH8 data output pins to the oscilloscope CH1 and CH2 inputs using the SMB-to-BNC cables.

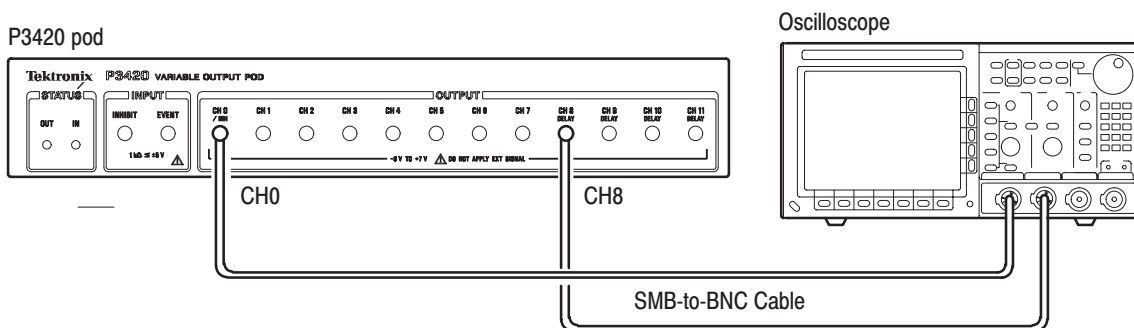

Figure B-24: Variable delay precision check

Setup

- Oscilloscope
 - Displayed channels CH1 and CH2
 - Vertical axis 2 V/div
 - Horizontal axis . . . 2 ns/div
 - MEASURE CH1 → CH2 DLY
 - Record Length . . . 2500 points in 50 divs
 - Trigger source CH1
 - Input coupling
 - (CH1 and CH2) . . DC
 - Input impedance
 - (CH1 and CH2) . . 1 MΩ

Characteristics Confirmation Procedure

1. Load the **TP7DELAY.PDA** test pattern file from the performance check disk.
2. Press the following keys in the order shown. In the present state the CH8 through CH11 delay settings will all be 0.0 ns.

Menu button	Bottom button	Popup menu	Side button	Front panel button
SETUP	Level/Delay			
Move the cursor to CH08 with the general purpose knob.				
			Delay	

3. Press the **START/STOP** button on the front panel so that the button’s LED indicator lights.
4. Observe the two clock pulses on the oscilloscope, and read off the CH8 delay value referenced to CH0 with the timing measured between points with voltages of 50 % of the peak value. Confirm that the values measured with the oscilloscope for the delay settings in Table B-8 fall within the delay span ranges in the table below.

Table B-8: Delay precision

Settings	Delay span range
0.0 ns	-0.80 ns to 0.80 ns
2.0 ns	1.14 ns to 2.86 ns
5.0 ns	4.05 ns to 5.95 ns
10.0 ns	8.90 ns to 11.10 ns
20.0 ns	18.60 ns to 21.40 ns

5. Move the pin header cable connected to the P3420 CH8 to channels CH9 through CH11 in turn, and repeat step 3 to confirm the delay values.

Event Input and Inhibit Input

This test confirms that the event jump and inhibit operations function correctly in response to signals applied to the P3420 pod event and inhibit inputs.

Required Equipment

- DG2020A
- Oscilloscope
- Pod connection cable
- SMB-to-BNC cable
- SMB to SMB cable
- Performance check disk

Connections. Connect the P3420 CH0 output connector to the oscilloscope CH1 input using an SMB-to-BNC cable. Also, connect the P3420 CH1 output pin to the P3420 pod **EVENT INPUT** using an SMB to SMB cable.

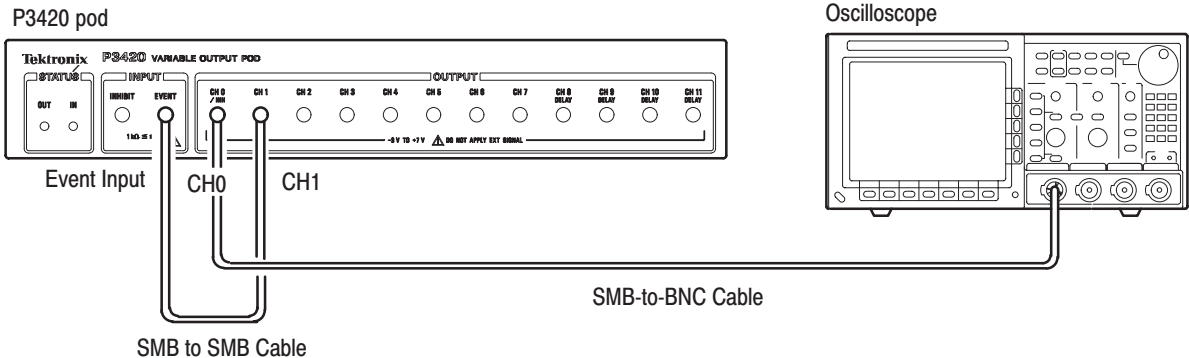

Figure B-25: Event input operation confirmation connections

Setup

- Oscilloscope
 - Displayed channel CH1
 - Vertical axis 2 V/div
 - Horizontal axis . . . 200 ns/div
 - Trigger mode Auto
 - Trigger level 1.5 V
 - Input coupling DC
 - Hold off 9 μs
 - Input impedance . . 1 MΩ

Characteristics Confirmation Procedure

The following three steps confirm the event input operation.

1. Load the **TP5EVENT.PDA** test pattern file from the performance check disk.
2. Press the **START/STOP** button on the front panel so that the button's LED indicator lights.
3. Confirm that a 1 μ s square wave and a 500 ns square wave are displayed on the oscilloscope alternately for 1 cycle and 2 cycles respectively.

The following four steps confirm the inhibit input operation.

4. Remove the SMB connector connected to the pod CH0 and connect it to CH2. Next, remove the SMB connector connected to CH1 and connect it to CH0. Remove the SMB connector connected to **EVENT INPUT** and connect it to **INHIBIT INPUT**.

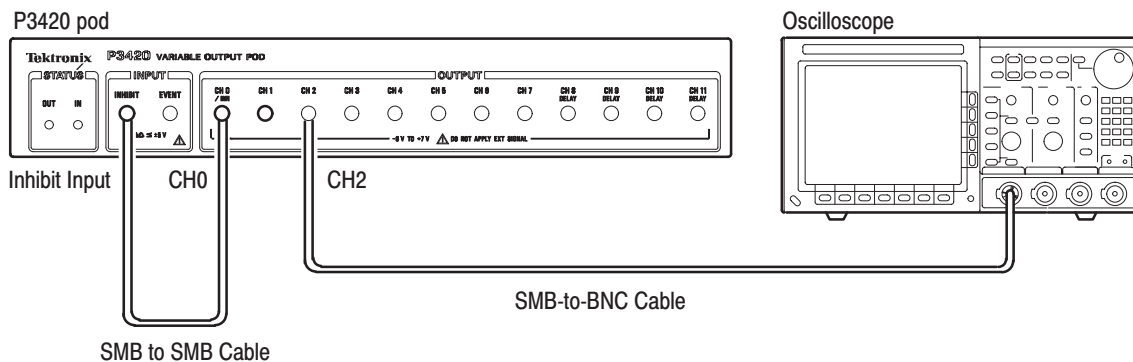

Figure B-26: Inhibit input operation confirmation connections

5. Set the oscilloscope CH1 input impedance to 50 Ω .
6. Press the **START/STOP** button on the front panel twice.
7. Confirm that a square wave with a 1 μ s period is displayed on the oscilloscope.

Appendix C: Miscellaneous

This appendix covers the following items.

- Repackaging for Shipment
- Inspection and Cleaning
- Factory Settings
- Conversion Table Examples

Repackaging for Shipment

If this instrument is shipped by commercial transportation, use the original packaging material. Unpack the instrument carefully from its shipping container so that the carton and packaging material can be used for repackaging.

If the original packaging is unfit for use or is not available, repackage the instrument as follows:

1. Obtain a corrugated cardboard shipping carton having inside dimensions at least six inches greater than the instrument dimensions and having a carton test strength of at least 275 pounds.
2. If the instrument is being shipped to a Tektronix Service Center for repair or calibration, attach a tag to the instrument showing the following: the owner of the instrument (with address), the name of a person at your firm who may be contacted if additional information is needed, the complete instrument type and serial number, and a description of the service required.
3. Wrap the instrument with polyethylene sheeting or equivalent to protect the outside finish and prevent entry of packing materials into the instrument.
4. Cushion the instrument on all sides by tightly packing dunnage or urethane foam between the carton and the instrument, allowing for three inches of padding on each side (including top and bottom).
5. Seal the carton with shipping tape or with an industrial stapler.
6. Mark the address of the Tektronix Service Center and your return address on the carton in one or more prominent locations.

Inspection and Cleaning Procedures

Inspect and clean the instrument as often as operating conditions require. The collection of dirt can cause instrument overheating and breakdown. Dirt acts as an insulating blanket, preventing efficient heat dissipation. Dirt also provides an electrical conduction path that can cause an instrument failure, especially under high-humidity conditions.



CAUTION. Avoid the use of chemical cleaning agents that might damage the plastics used in this instrument. Use only deionized water when cleaning the menu buttons or front-panel buttons. Use a ethyl alcohol solution as a cleaner and rinse with deionized water. Before using any other type of cleaner, consult your Tektronix Service Center or representative.

Avoid the use of high pressure compressed air when cleaning dust from the interior of this instrument. (High pressure air can cause ESD.) Instead, use low pressure compressed air (about 9 psi).

Inspection — Exterior

Using Table C-1 as a guide, inspect the outside of the instrument for damage, wear, and missing parts. You should thoroughly check instruments that appear to have been dropped or otherwise abused to verify correct operation and performance. Immediately repair defects that could cause personal injury or lead to further damage to the instrument.

Table C-1: External inspection check list

Item	Inspect for	Repair action
Cabinet, front panel, and cover	Cracks, scratches, deformations, damaged hardware or gaskets	Replace defective module
Front-panel knobs	Missing, damaged, or loose knobs	Repair or replace missing or defective knobs
Connectors	Broken shells, cracked insulation, and deformed contacts. Dirt in connectors	Replace defective modules. Clear or wash out dirt
Carrying handle and cabinet feet	Correct operation	Replace defective module
Accessories	Missing items or parts of items, bent pins, broken or frayed cables, and damaged connectors	Replace damaged or missing items, frayed cables, and defective modules

Cleaning Procedure — Exterior



WARNING. *To avoid injury or death, unplug the power cord from line voltage before cleaning the instrument. To avoid getting moisture inside the instrument during external cleaning, use only enough liquid to dampen the cloth or applicator.*

1. Remove loose dust on the outside of the instrument with a lint-free cloth.
2. Remove remaining dirt with a lint free cloth dampened in a general purpose detergent-and-water solution. Do not use abrasive cleaners.
3. Clean the monitor screen with a lint-free cloth dampened with either ethyl alcohol or, preferably, a gentle, general purpose detergent-and-water solution.

Factory Settings

When **Reset to Factory** is selected from the **UTILITY System** menu, this instrument's parameters are reset to the values they had when leaving factory. Table C-2 lists these factory settings.

Table C-2: Factory settings

SETUP menu	
Level/Delay	
High Level	3.0 V (open circuit)
Low Level	0.0 V
Delay	0.0 ns
Z on Stop	On
Pod Control	
Event Level	1.4 V
Inhibit Level	1.4 V
POD Event	Enable
Run Mode	
Run mode	Repeat
Update	Auto
Trigger	
Slope	Positive
Level	1.4 V
Impedance	1 K Ω
Oscillator	
Source	Internal
Int Frequency	100.00 MHz
Ext Frequency	100.00 MHz
PLL	On
UTILITY menu	
Mass Memory	
Special → Catalog Order	NAME1
Display	
Clock	Off
Brightness	70%
Dimmer	Off

Table C-2: Factory settings (Cont.)

UTILITY menu	
Hardcopy	
Format	BMP
Port	DISK
System	
Power up Pause	On
Diag	
Type	All

The following menu items are not affected by **Reset to Factory**.

- Menu items in the **EDIT** menu
- The following **SETUP** items

Group number
Channel allocation
Pod allocation

However, when **Security Immediate** item is selected in the **UTILITY System** menu, the above items are reset.

- The following **UTILITY** items

Remote Port

GPIB operation mode and address
Serial parameters

Date/Time

Conversion Table Examples

Using the code conversion table, bit pattern can be converted to an other. Figure C-1 shows an image how the code conversion table is used.

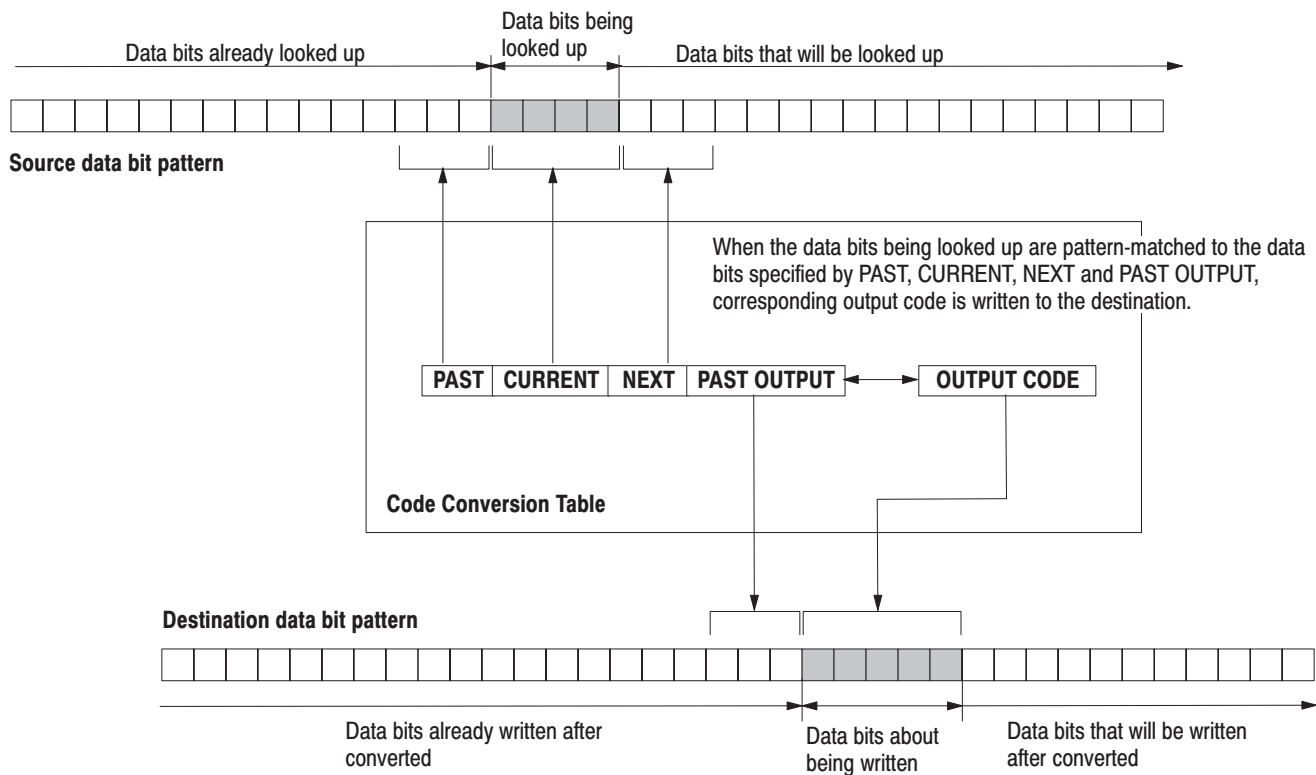

Figure C-1: Conversion image example

Examples In following examples, data bits to be written in the tables are introduced. And input and output data bit pattern example is following each table.

- Inverting bit of the **NRZ** data.

PAST	CURRENT	NEXT	P.OUT	OUTPUT CODE
	0			1
	1			0

Example

Input	0	1	0	0	1	1	0	0	0
Output	1	0	1	1	0	0	1	1	1

- Converting NRZ data to **NRZI**.

PAST	CURRENT	NEXT	P.OUT	OUTPUT CODE
	1		0	1
	1		1	0
	0		0	0
	0		1	1

Example

Input	0	1	0	0	1	1	0	0	0
Output	0	1	1	1	0	1	1	1	1

- Converting NRZ data to **NRZI**. Two bit are generated for each input bit.

PAST	CURRENT	NEXT	P. OUT	OUTPUT CODE
	1		0	01
	1		1	10
	0		0	00
	0		1	11

Example

Input	0	1	0	0	1	1	0	0	0
Output	00	01	11	11	10	01	11	11	11

- Converting NRZ data to **FM**. Two bit are generated for each input bit.

PAST	CURRENT	NEXT	P. OUT	OUTPUT CODE
	0		0	11
	0		1	00
	1		0	10
	1		1	01

Example

Input	0	1	0	0	1	1	0	0	0
Output	11	01	00	11	01	01	00	11	00

- Converting NRZ data to **BI-PHASE**. Two bit are generated for each input bit.

PAST	CURRENT	NEXT	P. OUT	OUTPUT CODE
	0			01
	1			10

Example

Input	0	1	0	0	1	1	0	0	0
Output	01	10	01	01	10	10	01	01	01

- Converting NRZ data to **RZ**. Two bit are generated for each input bit.

PAST	CURRENT	NEXT	P. OUT	OUTPUT CODE
	0			00
	1			10

Example

Input	0	1	0	0	1	1	0	0	0
Output	00	10	00	00	10	10	00	00	00

- Output bit is always set to 1 when input bit changes from 1 to 0 or 0 to 1.

PAST	CURRENT	NEXT	P. OUT	OUTPUT CODE
0	1			1
1	0			1
	1			0
	0			0

Example

Input	0	1	0	0	1	1	0	0	0
Output	0	1	1	0	1	0	1	0	0

- Converting NRZ data to 1-7 RLL (Run-length Limited Codes).

PAST	CURRENT	NEXT	P. OUT	OUTPUT CODE
	0000		1	100000
	0000		0	011111
	0001		00	111111
	0001		01	111111
	0001		10	000000
	0001		11	000000
	0010		01	111110
	0010		10	000001
	0010		00	111110
	0010		11	000001
	0011		1	100001
	0011		0	011110
	01		1	100
	01		0	011
	10		01	111
	10		10	000
	10		00	111
	10		11	000
	11		01	110
	11		10	001
	11		00	110
	11		11	001
	0			0
	1			1

Example

Input	01	10	11	0010	10	0011	11	0001	0011	10	0000
Output	011	000	110	000001	111	100001	110	000000	011110	000	011111

Index

A

- Accessories, 1-4
 - inspection of, C-2
- Add block delimiter here, 3-25
- Add Group, 3-65
- Address, 3-90
- Advanced Control for Sequence, 3-4
- APPLICATION Menu, 3-79
- Area and Point Cursors, 2-26
- Arrow Buttons, 2-3
- Assign, 3-68

B

- Basic Hardware Structure, 2-10
- Basic Menu Operation, 2-17
- Basic Operation Examples, 2-35
 - Before Starting Example, 2-36
 - Equipment Connections, 2-37
 - Operating Procedure Sequences, 2-36
 - Required Equipment, 2-35
- Baudrate, 3-91
- Bezel buttons, 2-2
- Binary display, 2-24
- Binary down counter, 3-40
- Binary up counter, 3-40
- Bit Operation, 3-49
- Block delimiter, 2-14
- Block division, 2-14
- Block Menu, 3-24
- Block Relative Cursor Movement, 3-24
- Bottom Menu, 2-7, 2-19
- Brightness, 3-87
- Button Function Description Area, 2-7

C

- Cabinet, inspection of, C-2
- Catalog Order, 3-85
- Change Directory, 3-83
- Change Inhibit Control, 3-69
- Cleaning
 - agents, C-2
 - compressed air, C-2
 - exterior, C-3
 - instrument cabinet, C-3
- Cleaning, Inspection and cleaning procedures, C-2
- CLEAR MENU Button, 2-2

- Clear Message Area, 3-89
- Clock, 3-87
- CLOCK IN Connector, 2-4
- CLOCK OUT Connector, 2-4
- Clock Pattern, 3-42
- Clock Unit, 2-11
- Configure, 3-90
- Connectors, inspection of, C-2
- Conversion Table Examples, C-6
- Copy, 3-31, 3-84
- Copy or Delete, 3-84
- CPU Unit, 2-11
- Creating Standard Pattern Data, 3-40
- CURSOR Button, 2-3
- Cut, 3-31

D

- Data Bits, 3-91
- Data Structure Basics, 2-13
- Date and Time Display Area, 2-7
- Date/Time, 3-92
- Delay, 3-71
- Delete, 3-84
- Delete All, 3-84
- Delete current block delimiter, 3-26
- Delete Group, 3-66
- Delete Key, 2-3
- Delete sequence step, 3-56
- Diag Menu, 3-93
- Dimmer, 3-87
- Display, 3-86
- Display and Front Panel, 2-12
- display elements, 2-6
- Display/Hardcopy Menu, 3-86

E

- Edit Operations, 2-25
- Enhanced, 3-74
- Enhanced Action Menu, 3-42
- ENTER Button, 2-3
- Event Level, 3-71
- EVENT OUTPUT, 2-2
- Example 1: Creating a Pattern and Storing it in a File, 2-39
- Example 2: Loading and Editing a Pattern Stored in a File, 2-42
- Example 3: Signal Output, 2-46

Example 4: Creating a Sequence, 2-54
Execute Action Menu, 3-28
EXECUTE Button, 2-3
Export, 3-15
Ext Frequency, 3-78

F

Factory Settings, C-4
File Menu, 3-9
FORCE TRIGGER Button, 2-3
Format, 3-88
Formating Data, CSV format, 3-13
Front Panel, 2-1
Front panel, knobs, inspection of, C-2

G

General Purpose Knob, 2-3
Graycode counter, 3-40
Group allocation, 2-14
Group Assign Menu, 3-65
Group bit(s) Config, 3-67

H

Handshake, 3-91
Hardcopy, 3-88
HARDCOPY Button, 2-3
Hardware Block Diagram, 2-10
High Level (P3420 only), 3-70

I

IEEE STD 488 Connector, 2-4
Impedance, 3-77
Import, 3-10
Inhibit Function, 2-12
Inhibit Level, 3-72
Initial Inspection, 1-2
Initialize Media, 3-85
Insert, 3-55
Insert high data, 3-33
Insert low data, 3-33
Inspection, exterior, C-2
Inspection and cleaning procedures, C-2
Inspection checklist, external, C-2
Installation, 1-7
Int Frequency, 3-77
Internal Structure and Operating Principles, 2-10
Invert data, 3-33

J

Johnson counter, 3-40

L

Level, 3-76
Level/Delay Menu, 3-70
Load Data & Setup, 3-9
Lock, 3-85
Logical Operation, 3-47
Low Level (P3420 only), 3-70

M

Magnify, 3-35
Maintenance kit, list of contents, 1-6
Make Directory, 3-83
Make Sequence Menu, 3-54
Mass Memory Menu, 3-83
Memory size, 2-14
MENU Buttons, 2-3
Menu Item Display, 2-19
menu notation, 2-18
Menu Operations, 2-17
Message Display, 2-7
Message Display Area, 2-7
Mirror horizontal, 3-35
Mirror Vertical, 3-34
Monitor, cleaning, C-3
Move cursor to prev/next block, 3-21
Move cursor to prev/next edge in reference group, 3-21
Move cursor to prev/next edge in selected group, 3-21
Move cursor to prev/next index, 3-21
Move to block (any), 3-24
Move to block end, 3-24
Move to block start, 3-24
Move to next block, 3-24
Move to previous block, 3-24

N

New, 3-17
Nominal Traits, A-9
Numeric Input, 2-20
Numeric input, 3-35
Numeric Input Examples, 2-21
Numeric Input Keys, 2-20
Numeric inputs using the numeric keys, 2-20
Numeric Keys, 2-3

O

ON/STBY Button, 2-2
 Operating Modes Overview, 2-16
 Operation Outlines, 3-2
 Option 01 (24 Channel Output), 1-3
 Option 02 (36 Channel Output), 1-3
 Option 1R (Rack Mount), 1-3
 Optional Accessories, 1-5
 Options, 1-3
 Oscillator Menu, 3-77
 Outlines for Pattern data Sequence Creations, 3-3
 Output Pod, 2-11

P

P3410 Front and Rear Panel, 2-8
 P3410 Pod Performance Test, B-17
 P3420 Front and Rear Panel, 2-9
 P3420 Pod Performance Test, B-24
 Parity, 3-91
 Paste insert, 3-31
 Paste-replace, 3-32
 Pattern Data, 2-13
 Pattern data, 2-14
 Pattern Data Display Format, 2-23
 Pattern Data Output Connector, 2-4
 Pattern Generation Unit, 2-11
 Performance Conditions, A-2
 Performance Tests for the DG2020A/Pod Combination,
 B-6
 Place mark here, 3-18
 PLL, 3-78
 POD A Event, 3-72
 Pod allocation, 2-14
 Pod Assign Menu, 3-68
 Pod Control Menu, 3-71
 Pop up Menu, 2-7
 Port, 3-88
 Power Connector, 2-4
 Power Cord Identification, 1-11
 Power Cord Options, 1-3
 Power Off, 1-14
 Power On, 1-12
 Power Supply Fuse Holder, 2-4
 Power up Pause, 3-91
 PRINCIPLE POWER SWITCH, 2-4
 Procedures, inspection and cleaning, C-2
 Product Description, 1-1

R

Rear Panel, 2-4
 Release, 3-69
 Remote Port, 3-89
 Rename, 3-67, 3-83
 Rename current block, 3-27
 Repackaging for Shipment, C-1
 Repeat, 3-73
 Repeat Count, 3-56
 Reset All bits Assign, 3-67
 Reset to Factory, 3-92
 Resize current block, 3-27
 Rotate down, 3-40
 Rotate left, 3-39
 Rotate region left/right, 3-21
 Rotate region up/down, 3-21
 Rotate right, 3-39
 Rotate up, 3-40
 RS232C Connector, 2-4
 Run Mode Menu, 3-73
 Run Modes, 2-16

S

Save Data & Setup, 3-9
 Security Immediate, 3-92
 Select arrow key function, 3-20
 Select reference group, 3-18
 Self Tests, B-5
 Sequence Data, 2-14
 Sequence data, 2-14
 Serial Code Converter, 3-50
 Set data to high, 3-32
 Set data to low, 3-32
 Set Enhanced Control, 3-56
 Set memory size, 3-19
 Set scope, 3-30
 Set view type to binary, 3-23
 Set view type to table, 3-23
 Set view type to timing, 3-23
 Setting the Pattern Data Display Format, 3-22
 Setting Values with the General Purpose Knob, 2-22
 Settings Menu, 3-17
 Setup Data, 2-13
 Setup data, 2-14
 Shift left, 3-37
 Shift left (add zero), 3-37
 Shift region left/right, 3-21

Shift region left/right (add zero), 3-21
Shift region up/down, 3-21
Shift region up/down (add zero), 3-21
Shift Register Generator, 3-44
Shift right, 3-37
Shift right (add zero), 3-37
Side and Sub Menus, 2-19
Side Menu, 2-7
Side Panel, 2-5
Single, 3-73
Slope, 3-76
Source, 3-77
Special, 3-57, 3-85
Standard Accessories, 1-4
START/STOP Button, 2-3
Start-up Diganostics, 1-14
Status Area, 2-7
Status Menu, 3-93
Step, 3-74
STEP/EVENT Button, 2-3
Stop Bits, 3-91
Sub-sequence, 3-57
SYNC OUTPUT, 2-2
System Menu, 3-89

T

Table display, 2-24
Test Procedure Notes, B-4
Text Input, 2-28
Timing display, 2-23
TRIGGER INPUT, 2-2
Trigger Menu, 3-76
Typical Characteristics, A-7

U

Units Buttons, 2-3
Unselect reference group, 3-19
Update, 3-75
Update Modes, 2-16

W

Warranted Characteristics, A-2

Z

Z on Stop, 3-71